

Installation Guide

Underlay

James Hardie™
Ceramic Tile Underlay

James Hardie™
Vinyl And Cork Underlay

INTERIORS

Australia May 2019

Make sure your information is up to date.

When specifying or installing James Hardie™ products, ensure that you have the current technical information and guides. If in doubt, or you need more information, visit www.jameshardie.com.au or Ask James Hardie™ on 13 11 03.

1 INTRODUCTION

James Hardie® manufactures two types of fibre cement underlays for use under tiles, vinyl and cork and in timber flooring applications. All of these James Hardie™ underlays come with a pre-marked nailing pattern and are suitable for use over internal timber, particle board or plywood floors in wet and dry areas.

James Hardie™ Ceramic tile underlay is a larger underlay sheet with pre-marked nailing pattern on the face. Its main features are:

- Larger board size is ideal for bigger bathrooms and large floor areas being tiled.
- Sealer increases cement based tile adhesive working time by 50%.
- Can be used in wet and dry areas.
- Durable and reliable.
- Minimises tile movement, reducing the potential for tile cracking.

James Hardie™ Vinyl and cork underlay is a pre-marked sheet which provides a smooth base for vinyl and cork flooring finishes.

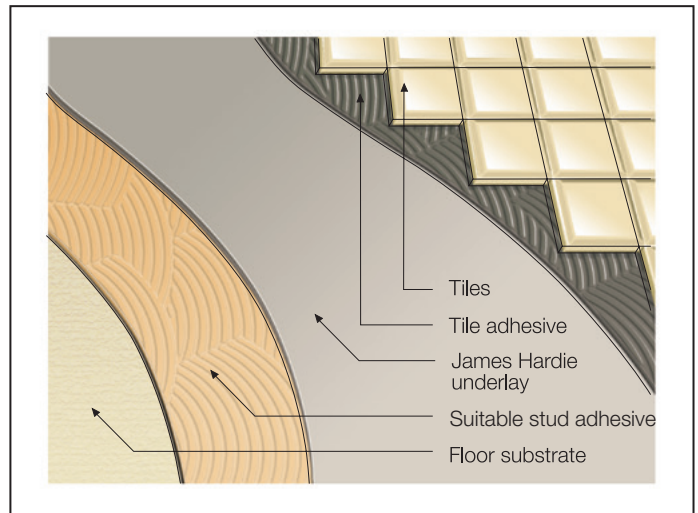

The specifier or other responsible party for the project must ensure the information and details in this guide are appropriate for the intended application and that specific design and detailing is undertaken for areas which fall outside the scope of this documentation.

For wet area applications this guide must be read in conjunction with James Hardie Wet Area Construction Application Guide which provides wet area waterproofing requirements and details.

CONTENTS





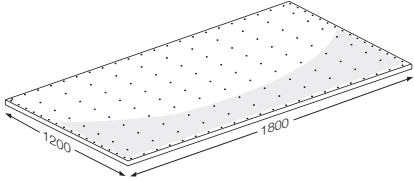
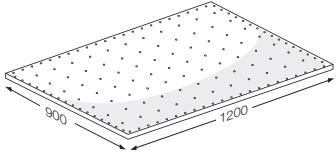

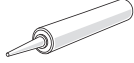

1	INTRODUCTION	2
2	SAFE WORKING PRACTICES	4
	Warning	4
	Recommended safe working practices	4
	Working instructions	4
	Hole-forming	5
	Storage and handling	5
	Quality	5
3	PREPARATION	6
	General	6
	Underfloor ventilation	6
	Existing timber floors	6
	Substrate preparation	6
4	INSTALLATION	7
	Installation steps	7
	Additional requirements for vinyl and cork underlay	8
5	MOVEMENT JOINTS	9
6	FINISHES	9
	General	9
	Slate floor tiles	9
	Marble floor tiles	9
7	MAINTENANCE	10
8	PRODUCT INFORMATION	10
	General	10
	Product mass	10
	Durability	10

TABLE 1

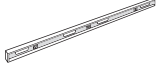
JAMES HARDIE™ UNDERLAYS INFORMATION		
PRODUCT	DESCRIPTION	QUANTITY / SIZE
	<p>James Hardie™ Ceramic tile underlay Fibre cement underlay sheet with pre-marked nailing pattern on the face. Suitable for ceramic tiles.</p> <p>Approx. mass: 17.5kg per sheet</p>	<p>Thickness: 6mm Width: 1200mm Length: 1800mm</p> <p>Part No: 403190 30 Per Pack</p>
	<p>James Hardie™ Vinyl and cork underlay Fibre cement underlay sheet with pre-marked nailing pattern on the face. Suitable for vinyl and cork finishes.</p> <p>Approx. mass: 7kg per sheet</p>	<p>Thickness: 5mm Width: 900mm Length: 1200mm</p> <p>Part No: 400459 30 Per Pack</p>

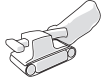
*All dimensions and masses are approximate and subject to manufacture tolerances.

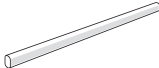
TABLE 2

PRODUCT / ACCESSORIES / TOOLS			
COMPONENTS SUPPLIED BY JAMES HARDIE			
ACCESSORIES	DESCRIPTION	ACCESSORIES	DESCRIPTION
	<p>Villaboard™ Knife A score and snap knife designed to efficiently cut through fibre cement sheets ≤9mm thick. 12 per box. Part No. 305915.</p>		<p>James Hardie™ Joint Sealant. 300ml cartridge A general purpose, paintable, exterior grade polyurethane joint sealant. 20 per box. Part No. 305534</p>
COMPONENTS NOT SUPPLIED BY JAMES HARDIE			
James Hardie recommends the following products for use in conjunction with its underlay products. James Hardie does not supply these products and does not provide a warranty for their use. Please contact the component manufacturer for information on their warranties and further information on their products.			
ACCESSORIES	DESCRIPTION	ACCESSORIES	DESCRIPTION
	<p>Underlay nails 25mm x 2.5 fibre underlay nails, bright ringshank/annular.</p>		<p>Level/straight edge For checking straightness of underlying flooring.</p>
	<p>Underlay gun nails 27mm x 2.1mm bright steel, annular thread, flat head collated nail. C21/27R by DuoFast or Bostich 27mm x 2.1 nails</p>		<p>Sander For sanding uneven underlying flooring.</p>
	<p>Staples 22mm length x 5mm wide galvanised or copper etched, chisel point, narrow crown staple - resin coated. Suitable for vinyl and cork only.</p>		<p>Notched trowel For adhesive application to back of James Hardie underlay.</p>
	<p>Backing rod Backing to be used with sealant in movement joints.</p>		
	<p>Stud adhesive Used for adhering underlay onto particle board or plywood floors in tiled applications. 4 litre / 5.2Kg</p>		

2 SAFE WORKING PRACTICES

WARNING - DO NOT BREATHE DUST AND CUT ONLY IN WELL VENTILATED AREA

James Hardie™ products contain sand, a source of respirable crystalline silica which is considered by some international authorities to be a cause of cancer from some occupational sources. Breathing excessive amounts of respirable silica dust can also cause a disabling and potentially fatal lung disease called silicosis, and has been linked with other diseases. Some studies suggest smoking may increase these risks. During installation or handling: (1) work in outdoor areas with ample ventilation; (2) minimise dust when cutting by using either 'score and snap' knife, fibre cement shears or, where not feasible, use a HardieBlade™ Saw Blade (or equivalent) and dust-reducing circular saw attached to an appropriate, well maintained, filtered vacuum; (3) warn others in the immediate area to avoid breathing dust; (4) wear a properly-fitted, approved dust mask or respirator (e.g. P1 or P2) in accordance with applicable government regulations and manufacturer instructions to further limit respirable silica exposures. During clean-up use a vacuum and filter, both of which are well maintained and appropriate for capturing fine (respirable) dust. Alternatively, use wet clean-up methods - never dry sweep. For further information, refer to our installation instructions and Safety Data Sheets available at www.jameshardie.com.au. FAILURE TO ADHERE TO OUR WARNINGS, SAFETY DATA SHEETS, AND INSTALLATION INSTRUCTIONS MAY LEAD TO SERIOUS PERSONAL INJURY OR DEATH.

WORKING INSTRUCTIONS

Refer to recommended safe working practices before starting any cutting or machining of product.

Score and snap

Score and snap is a fast and efficient method of cutting James Hardie™ building products using James Hardie's Villaboard™ knife. Preferably score on the face side of the product. Score against a straight edge and repeat the action to obtain adequate depth for clean break – normally one third of sheet thickness. Snap upwards to achieve break. Smooth any rough edges with a rasp.

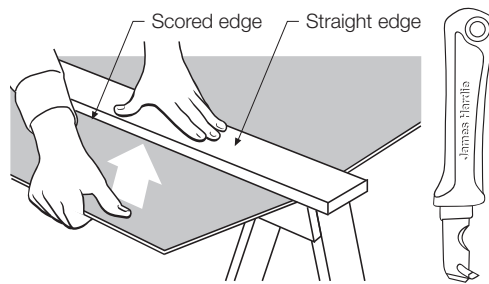

Hand guillotine

Make guillotine cut on the off-cut side of line to allow for the thickness of the blade.

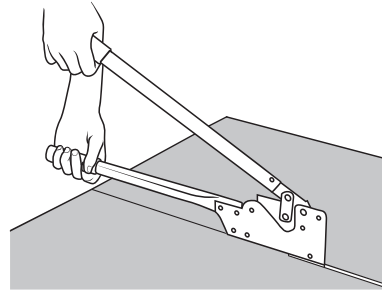

Fibreshear

An electrically powered, fast, clean and effortless way of cutting James Hardie building products, especially around curves such as archways. Make fibreshear cut on the 'off-cut' side of the line to allow for the thickness of the shear.

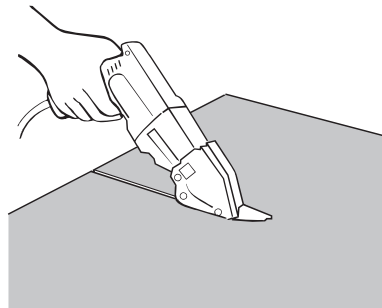

JAMES HARDIE RECOMMENDED SAFE WORKING PRACTICES

CUTTING OUTDOORS

1. Position cutting station so wind will blow dust away from the user or others in working area.
2. Use one of the following methods based on the required cutting rate:
 - Best** ■ Score and snap ■ Hand guillotine ■ Fibreshear
 - Better** ■ Position the cutting station in a well-ventilated area. Use a dust reducing circular saw equipped with HardieBlade™ Saw Blade or comparable fibre cement blade and well maintained vacuum and filter appropriate for capturing fine (respirable) dust.

CUTTING INDOORS

- Cut only using score and snap, hand guillotine or fibreshears (manual, electric or pneumatic).
- Position cutting station in a well-ventilated area

DRILLING / OTHER MACHINING

When drilling or machining you should always wear a P1 or P2 dust mask and warn others in the immediate area.

IMPORTANT NOTES

1. For maximum protection (lowest respirable dust production) James Hardie recommends always using best practice cutting methods where feasible.
2. NEVER use a power saw indoors.
3. ALWAYS use a circular saw blade that carries the HardieBlade™ logo or is of at least comparable performance.
4. NEVER dry sweep - Use wet suppression or appropriate vacuum and filter.
5. NEVER use grinders.
6. ALWAYS follow tool manufacturers' safety recommendations.

DUST MASKS AND RESPIRATORS

James Hardie recommends the use of P2 respirators as best practice. As a minimum, an AS/NZS1716 P1 respirator must be used when doing any activity that may create dust. For more extensive guidance and options for selecting respirators for workplaces please refer to Australian/New Zealand Standard 1715:2009 "Selection, Use and Maintenance of Respiratory Protective Equipment".

P1 or P2 respirators should be used in conjunction with the above cutting practices to minimise dust exposure.

For further information, refer to Safety Data Sheet (SDS) available at www.jameshardie.com.au. If concern still exists about exposure levels or you do not comply with the above practices, you should always consult a qualified industrial hygienist or contact James Hardie for further information.

HardieBlade™ Saw Blade

The HardieBlade™ Saw Blade used with a dust-reducing saw and HEPA vacuum extraction allows for fast, clean cutting of James Hardie™ fibre cement products. A dust-reducing saw uses a dust deflector or a dust collector which can be connected to a vacuum system. When sawing, clamp a straight-edge to the sheet as a guide and run the saw base plate along the straight edge when making the cut.

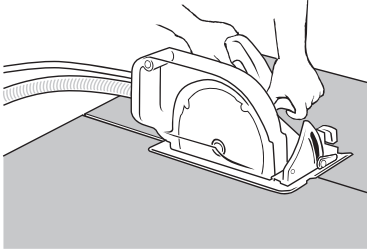

HOLE-FORMING

For smooth clean cut circular holes:

- Mark the centre of the hole on the sheet.
- Pre-drill a pilot hole.
- Using the pilot hole as a guide, cut the hole to the appropriate diameter with a hole saw fitted to a heavy duty electric drill.

For irregular holes:

- Small rectangular or circular holes can be cut by drilling a series of small holes around the perimeter of the hole then tapping out the waste piece from the sheet face.
- Tap carefully to avoid damage to sheets, ensuring the sheet edges are properly supported.

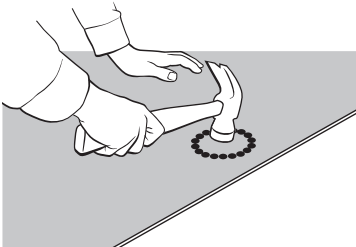

STORAGE AND HANDLING

To avoid damage, all James Hardie™ building products should be stored with edges and corners of the sheets protected from chipping.

James Hardie™ building products must be installed in a dry state and protected from rain during transport and storage. The product must be laid flat under cover on a smooth level surface clear of the ground to avoid exposure to water, moisture, etc.

QUALITY

James Hardie conducts stringent quality checks to ensure any product manufactured falls within our quality spectrum. It is the responsibility of the builder to ensure the product meets aesthetic requirements before installation. James Hardie will not be responsible for rectifying obvious aesthetic surface variations following installation.

3 PREPARATION

GENERAL

All construction must be carried out in accordance with the relevant building regulations and standards. Prior to installation, ensure the existing flooring and supporting framing is suitable for tiling. Contact your builder, designer or engineer if in doubt. Also check that the flooring is firmly fixed to floor joists.

UNDERFLOOR VENTILATION

Check that adequate ventilation exists under all timber floors (especially new floors) and that the areas are free from damp.

EXISTING TIMBER FLOORS

Remove all existing floor coverings to expose timber flooring. Check floor boards to make sure they are firmly nailed to the floor joist. Loose boards must be re-nailed firmly into place.

Floor boards must be reasonably flat for James Hardie™ Ceramic tile underlay. If the boards are badly warped or cupped the whole floor should be rough sanded before the underlay is fixed.

In the case of James Hardie™ Vinyl and cork underlay, it's essential that the floor boards are flat. If they aren't, the floor must be rough sanded before the underlay is fixed. It's recommended that floor sanding be carried out by an experienced tradesman.

Bearers must be in contact with piers. If they aren't, they should be packed to ensure there is no perceivable spring in the floor.

Ensure floor is clean of dust, dirt and grease before fixing underlay sheets.

NOTES

1. James Hardie™ ceramic tile underlay suited only as a substrate for tiles on timber floors. For tiling of walls use Villaboard® lining.
2. James Hardie underlays must not be used on concrete slabs. To build up height of concrete, purpose-made concrete levelling compounds are more suitable.

SUBSTRATE PREPARATION

Step 1

Use a straight edge to check that the timber floor is not out of level by more than 1mm over a 1m length.



Step 2

If the floor is warped or cupped the whole floor should be rough sanded before the underlay is fixed.



Step 3

Ensure floor substrate and James Hardie underlay sheets are clean of dust, dirt and grease before fixing underlay sheets.

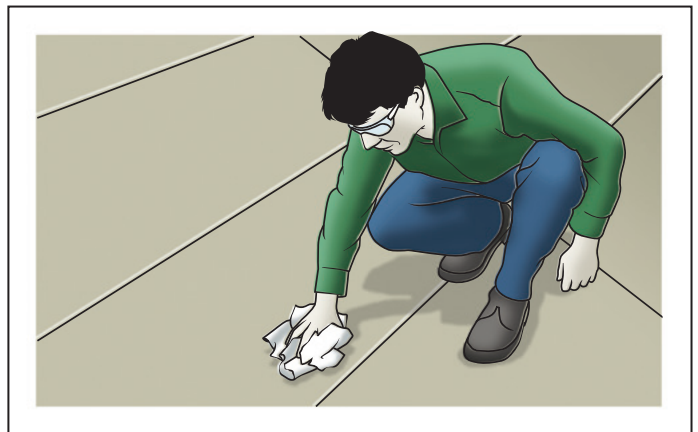

4 INSTALLATION

Step 1

Use a straight edge as a guide when scoring James Hardie™ Ceramic tile underlay and Vinyl and cork underlay as shown.

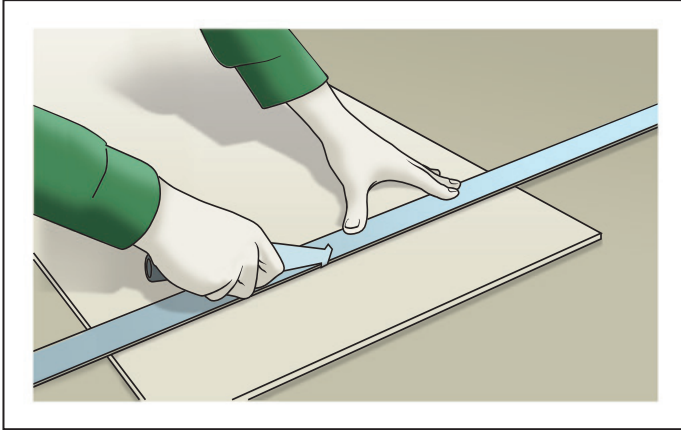

Step 2

Firmly support sheet near cut while snapping upward to break. For James Hardie™ Vinyl and cork underlay only, keep cut edges to the outside, i.e. against walls, cupboards, etc.



Step 3

Spread a suitable stud adhesive on the back of the underlay sheet with a 3mm notched trowel/spreader paying particular attention to the sheet edges. If fixing to hardwood floors, adhesive is not necessary.

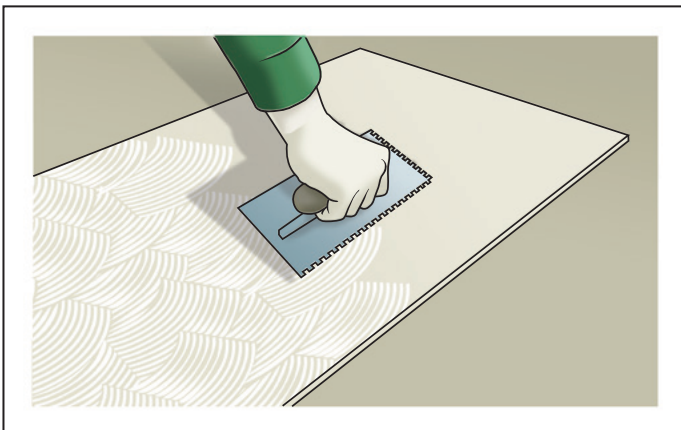

Step 4

Sheets are laid closely in a staggered (brick) pattern. Sheets are laid perpendicular to the direction of flooring substrate, as joins must not coincide with the joints in the timber floor (minimum offset of 100mm is required for sheet flooring substrates). Ensure sheet edges are 3mm back from walls. Temporarily fix each sheet with two or three nails or staples to avoid movement.

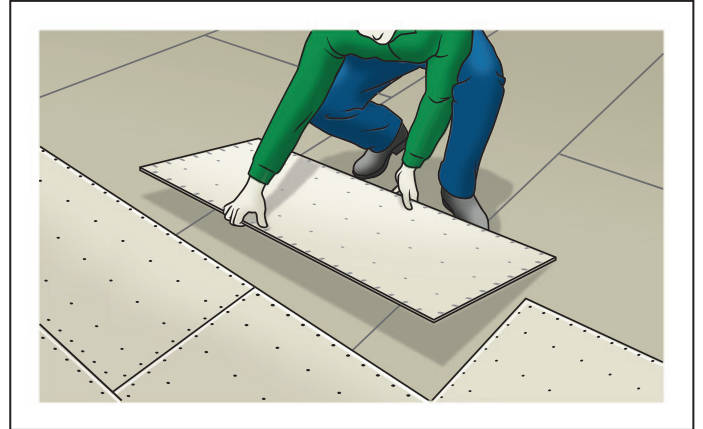

Step 5

Fix sheets from centre outwards using the pre-marked nailing pattern, driving fasteners flush with sheet surface. When hand nailing use 25mm x 2.5mm underlay nails. Staples may be used with James Hardie™ Vinyl and cork underlay on hardwood floors only. Staples should be driven so that the crown finishes 0.5mm below the sheet surface.

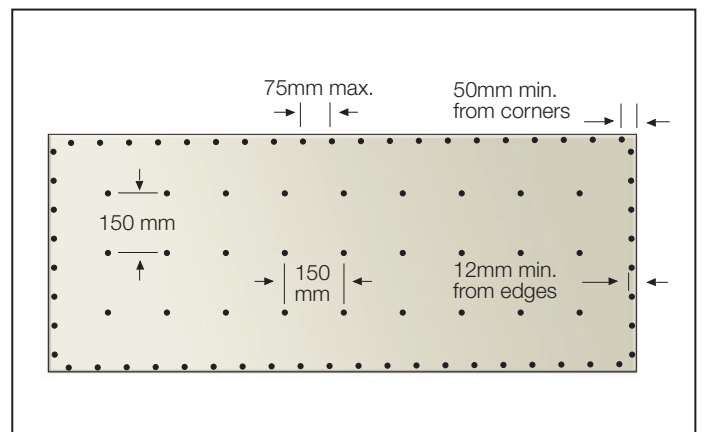

Step 6

Apply tile adhesive over James Hardie underlay in accordance with adhesive manufacturer's recommendations.



Step 7

Install tiles in accordance with tile manufacturer's recommendations.



ADDITIONAL REQUIREMENTS FOR JAMES HARDIE™ VINYL AND CORK UNDERLAY

Nails or staples can be used on hardwood floors. Only nails should be used on softwood floors. Staples should be driven so that the crown finishes approximately 0.5mm below the sheet surface. Nails should be driven absolutely flush with the surface of the sheet. Failure to do this can result in nail heads showing through floor coverings. Do not damage sheet face with hammer indentations.

Where minor height variations (3mm or less) occur at butt joints, these may be levelled out by filling with Ardex Feather Finish (Refer to Ardex for more information) or equivalent, instead of sanding. Ensure this is dry prior to applying the adhesive.

Flush-sand all joints between sheets and the areas created by fasteners with a belt or rotary sander. The Vinco No. SV25 upright sander and Makita belt sander No.9401 fitted with a No.401 vacuum cleaner are recommended. Use aluminium oxide or silicone carbide medium grit papers. All sanders must be fitted with effective dust collection devices – see recommended safe working practices.

Failure to provide an absolutely smooth, ridge and indentation-free underlay surface will cause unsightly blemishes to appear on the vinyl or cork floor coverings.

Never dry sweep the sanded floor - vacuum only. Where cork tiles or sheeting are to be laid, reseal sanded areas with Cemstick or Bondcrete. Allow resealed areas to dry before laying the floor covering.

5 MOVEMENT JOINTS

Provide movement joints where floor dimensions exceed 5m in one or both directions or where existing structural joints are located. Position joints symmetrically about the centre of the floor as shown below.

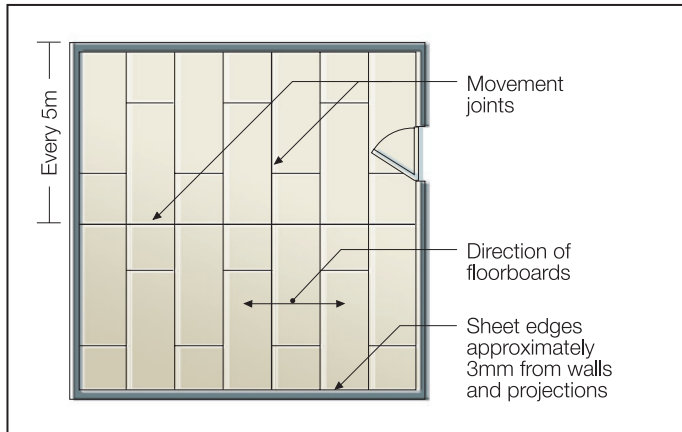

Also provide movement joints where there are changes of direction, such as an L-shaped room, and at doorways where the tiled surface is carried through to the next room as shown.

At the movement joint, ensure the gap comes through sheet and tiles. Place a polyethylene backing rod in the bottom of the joint between the underlay sheets and top the joint off with a suitable sealant.

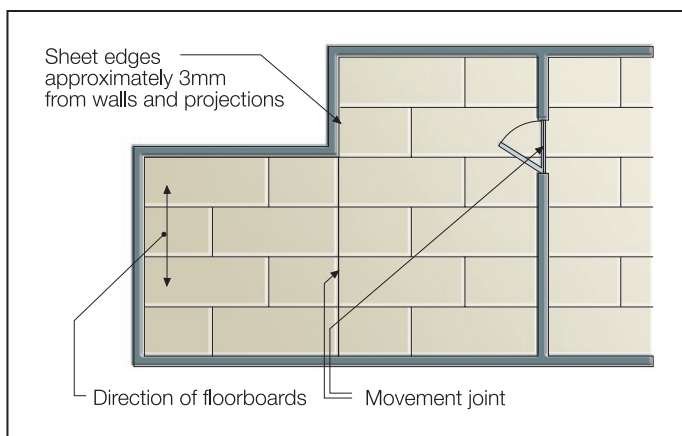

The width of the movement joint should be approximately equal to the width of the grout line. It is important that the movement joints be carried through to the top of the floor surface i.e. they should not be covered by tiles.

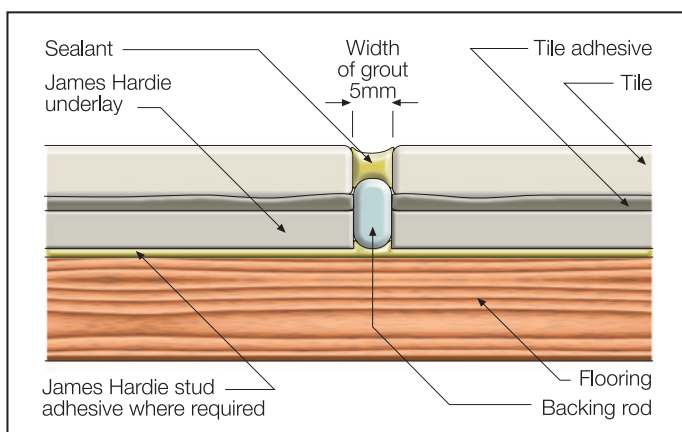

6 FINISHES

GENERAL

James Hardie underlays must be finished with a suitable floor covering i.e. ceramic floor tiles, vinyl tiles or sheeting, or cork tiles. For the suitability and installation requirements of floor coverings, check with the manufacturer.

SLATE FLOOR TILES

Slate may be used in much the same way as ceramic tiles. The slate should not be less than about 9mm thick.

MARBLE FLOOR TILES

Marble is a relatively weak material and if used as a flooring material should be isolated from structural movement. This can be achieved by modifying the flooring system to incorporate a fully reinforced mortar bed as shown below. It is recommended that the services of a tradesperson experienced in the application of marble tiles be obtained.

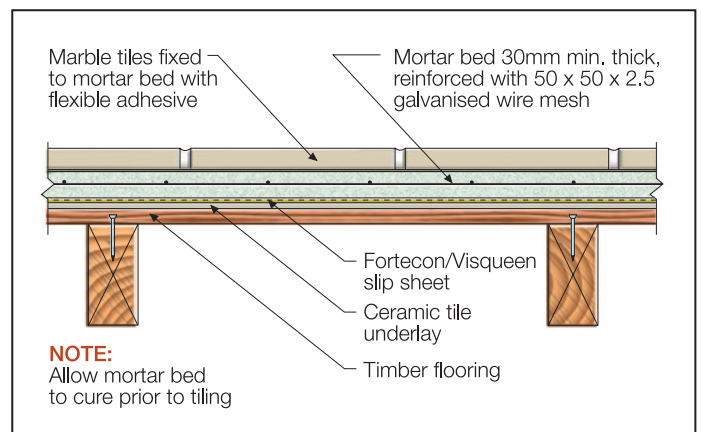

7 MAINTENANCE

Regular checks and maintenance of components including sealant, grout and waterproofing must be done as required by the manufacturer.

Certain floor coverings have protective clear coatings which enhance the durability and prolong the life of such floor coverings. For maintenance requirements check with both the floor covering and coating manufacturer.

8 PRODUCT INFORMATION

GENERAL

The basic composition of James Hardie™ building products is Portland cement, ground sand, cellulose fibre, water and proprietary additives.

James Hardie™ building products are manufactured AS/NZS 2908.2 'Cellulose-Cement Products-Flat Sheet'. These are also compliant with equivalent standard ISO 8336 'Fibre-cement flat sheets - Product specification and test methods'. For product classification refer to the relevant Physical Properties Data Sheet.

PRODUCT MASS

Based on equilibrium moisture content the approximate mass of:

- James Hardie™ Ceramic tile underlay is 8.1 kg/m².
- James Hardie™ Vinyl and cork underlay is 6.7 kg/m².

DURABILITY

Resistance to moisture/rotting

James Hardie underlays have demonstrated resistance to permanent moisture induced deterioration (rotting) by passing the following tests in accordance with AS/NZS 2908.2:

- Water permeability (Clause 8.2.2)
- Warm water (Clause 8.2.4)
- Heat rain (Clause 6.5)
- Soak dry (Clause 8.2.5)

Resistance to Fire

James Hardie flooring products have been tested to AS/ISO 9239, and exceed the requirements stipulated in the National Construction Code (NCC) - Specification C1.10a Fire Hazard Properties – Floors, Walls & Ceilings. All James Hardie flooring products have a critical radiant flux values greater than the minimum requirement of 4.5 kW/m² (highest value in accordance with Table 1), and a smoke development rate well below the maximum allowable smoke development rate of 750 percentage-minutes.

Resistance to termite attack

Based on testing completed by CSIRO Division of Forest Products and Ensis Australia James Hardie building products have demonstrated resistance to termite attack.



**For information and advice
call 13 11 03 | jameshardie.com.au**

Australia May 2019



© 2019 James Hardie Australia Pty Ltd ABN 12 084 635 558
™ and © denote a trademark or registered mark owned by James Hardie Technology Limited.