



Abey^{AU}

abeytrade.com.au

Plumber's Guide

Aussie Made for
Aussie Trades

















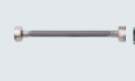

THE TRADIE'S CHOICE



Aussie Owned & operated since 1953

Established in 1953 Abey is an iconic third generation family owned Australian company. Abey is represented in all Australian states, manufacturing and marketing a vast range of over 1,500 products within the plumbing, building and retail sectors.

One of Australia's largest manufacturers and innovators of quality light weight sheet steel products employing over 120 Aussies. Abey's state of the art in-house facilities enable them to successfully compete with overseas imports. Their consistent record of innovation and quality has enabled them to satisfy and surpass their customers needs, producing superior high performance products.

															
Safety Belt Components for passenger vehicles	Produce unique products for Building industry	Invented Bolted Clipping system	Invented the Flexishaft Skylight system	Moved to state of the art factory/warehouse	Invented Speed clipping range developed	Revolutionary non corrosive High Class Hookers	Inroduced Channel Clips into the range								
1953	1956	1965	1967	1975	1979	1987	1989	1990	1999	2006	2014	2017	2018	2019	2020
A&B tool & Die Manufacturers established	Bigger factory & warehouse in Airport West	Introduced revolutionary Duravent	1st to introduce flexi plumbing connectors	Invented Stainless Steel non corrosive Brick ties	Introduced Airflex system	New stainless steel Airflex	Invented new Acoustic Clamps								
															

Abey^{AU}

abeytrade.com.au

Introduction

This Plumbing Guide has been developed to assist plumbers in selecting and using a range of Abey plumbing products. Abey is a wholly Australian owned 3rd generation family company. All Abey plumbing products are proudly Australian made to conform to Australian and New Zealand Building Standards and conditions. Other products in the Abey range have been sourced and selected from all over the world as being “best of breed”, providing plumbers the best world-class solutions that help save time, money or space. Abey have been assisting plumbers for over 60 years by developing and manufacturing innovative and unique plumbing products, which is why Abey are ‘The Tradie’s Choice’.



Contents

Introduction	4
Interchangeable Bolted Clips	6-11
– Bolted Clip Heads	
– Brackets, Shanks & Extensions	
– Abey’s Stainless Steel Clipping Range	
– Stand Off Clips	
– Hanging Clips	
Industrial Bolted Clips	14-22
– Nut Clips	
– Channel Clips	
– Industrial Stand Off Brackets	
– All Thread Clips	
– Pear Clips	
– Acoustic Pipe Clip	
Standard Pipe Clipping	23-26
– Saddle Clips	
Abey McAlpine Plastic Products	27-37
– Self-Closing Space Saver Waste Valve	
– Air Admittance Valves (Ventapipe)	
– All-In-One AAV Speed Trap	
– Bottle Traps & Self Closing Waste Valves	
– WC Connectors	
– Macvalve Self-Closing Waste Valve	
– NEW Redback Strapped Knee Pads	
– Flexible Waste Connectors	
– Accessories	
General Plumbing	38-41
– Stainless Steel Cover Plates	
– Polyamide High Class Hookers	
Roofing	42-43
– Downpipe Pops & Clips	
– Crimp Bends, China Hat Cowls & Rainheads	
Gas & Rangehood Flueing	44-47
– Rangehood Flueing Kits & Flueing Products	

INTERCHANGEABLE BOLTED CLIPS

The leaders in innovation, Abey understand the plumbing industry and the needs of tradesmen. Over the years they have continuously developed products designed to be simple to use, highly effective and totally reliable. Abey Australia, a leading manufacturer of plumbing products for over 60 years has introduced a number of innovations for plumbers over the years to simplify their work. Given the importance of time in the building and plumbing industry, contractors and tradies are constantly looking for better ways of doing even the simplest of jobs faster, efficiently and cost-effectively. Abey's first interchangeable bolted clipping system revolutionised the plumbing industry, and became the industry standard for over 30 years.

Abey's 'interchangeable' bolted clipping system has been engineered to the most stringent specifications and manufactured to suit all pipe sizes for domestic installations. Manufactured in Australia from G2-Z275 galvanised steel and further powder coated to colour match Copper, BSP, HDPE and PVC DWV pipes as well as extra corrosion resistant stainless steel.



Watch our instructional video at abeytrade.com.au

- The system provides a more streamlined and superior aesthetic finish
- Engineered to meet Australian and New Zealand building Codes
- Unique engineering feature creates a system of interchangeable Clips, Shanks and Brackets to minimise stock

All Clip Heads engineered to meet exact specifications to allow for expansion and contraction. Notice the elongated recess and square hole. They are designed to ensure perfect alignment and eliminate movement.



Spacing of Brackets & Clips

The following spacing limitations for horizontal and vertical piping are derived from AS 3500. It is to be noted that with fire sprinkler installations an additional bracket is required to support a sprinkler branch within 300mm of the sprinkler.





Sprinkler piping shall be supported from structural members and clips designed to withstand the anticipated stresses and loads. Piping shall be secured to restrict movement during its normal life and upon sprinkler operation.

MAXIMUM SPACING OF BRACKETS, CLIPS AND HANGERS

Pipework Material	Maximum Spacing Of Supports (Metres)	
	Vertical Pipes	Graded Pipes
Cast Iron	3	3
Ductile Iron	3	3
Copper, Copper Alloy	3	3
FRC	4	4
PVC-U DN 40-50	2	1
PVC-U DN 65-150	2.5	1.2
PVC-U DN > 150	3	1.5
PP	2	1
PE	2	1

DISCLAIMER: The information in this publication has been assembled for guidance only. Care has been taken to ensure accuracy, but no liability can be accepted for any consequence which may arise as a result of its application. It may not be reproduced in whole or in part without the written consent of Abey Australia Pty Ltd.

INTERCHANGEABLE BOLTED CLIPS BOLTED CLIP HEADS









PRODUCT DESCRIPTION		CODE
DWV PIPE BOLTED CLIP HEADS – GALVANISED & POWDER COATED WHITE 	DN40 1½" (50 per box)	0001/50
	DN50 2" (50 per box)	0002/50
	DN65 2½" (20 per box)	0003
	DN80 3" (20 per box)	0004
	DN90 3½" (20 per box)	0049
	DN100 4" (50 per box)	0005/50
	DN150 6" (20 per box)	0006
PVC EXPANSION BOLTED CLIP HEADS GALVANISED & POWDER COATED GREY 	DN65 2½" (20 per box)	0009
	DN80 3" (20 per box)	0010
	DN100 4" (20 per box)	0011
COPPER BOLTED CLIP HEADS GALVANISED & POWDERCOATED COPPER 	DN15 ½" (50 per box)	0026/50
	DN20 ¾" (50 per box)	0027/50
	DN25 1" (50 per box)	0028/50
	DN32 1¼" (20 per box)	0029
	DN40 1½" (50 per box)	0030/50
	DN50 2" (20 per box)	0031
	DN65 2½" (20 per box)	0032
	DN80 3" (20 per box)	0033
	DN100 4" (20 per box)	0034
BOLTED CLIP HEADS HDPE PIPE OD - GALVANISED & POWDERCOATED BLACK 	56mm (20 per box) NEW	0162
	63mm (20 per box) NEW	0163
	75mm (20 per box) NEW	0164
	110mm (20 per box) NEW	0166
PRESSURE PIPE CLIP HEADS - POWDERCOATED WHITE 	DN15 ½" (20 per box)	0040
	DN20 ¾" (20 per box)	0041
	DN25 1" (20 per box)	0042
	DN32 1¼" (20 per box)	0043
	DN40 1½" (20 per box)	0044
	DN50 2" (20 per box)	0045
	DN65 2½" (20 per box)	0046
DN80 3" (20 per box)	0047	



INTERCHANGEABLE BOLTED CLIPS BRACKETS, SHANKS & EXTENSIONS

PRODUCT DESCRIPTION		CODE
BRACKETS, SHANKS & EXTENSIONS – GALVANISED Bolted Clip Shanks 	300mm (25 per box)	0053
	450mm (10 per bag)	0054
	600mm (10 per bag)	0055
Extension Arms 	300mm (50 per box)	0058
Light Hanging Brackets 	300mm (30 per box)	0059
	600mm (10 per bag)	0082
Mounting Bracket Horizontal	10mm (50 per box)	5214
BRACKETS & EXTENSIONS – Stand Off Brackets 	Galvanised (50 per box)	0060
	Powder Coated (50 per box)	0078
Galvanised Adjustable Stand Off Brackets 	(50 per box)	0080/50
	Uncoated *(25 per box)	0079
All Thread Brackets 	includes 2 x 10mm Nuts (50 per box)	0061M
	10mm with Welded Nut (50 per box)	5061
Welded Nut Standoff Bracket 	M10 2.0 x 25mm (50 per box)	5160/50
Welded Nuts 	10mm (50 per box)	0063
V Legs 	(20 pair)	0066
Nuts and Bolts SHK 	7 x 25mm (100 per bag)	0068

ABEY'S STAINLESS STEEL CLIPPING RANGE FOR MAXIMUM CORROSION RESISTANCE

PRODUCT DESCRIPTION		CODE	
STAINLESS STEEL FOR PVC DWV PIPE CLIP HEADS		DN40 1½" (20 per box)	0001S
		DN50 2" (20 per box)	0002S
		DN90 3½" (20 per box)	0010S
		DN100 4" (20 per box)	0005S
STAINLESS STEEL FOR COPPER PIPE CLIP HEADS		DN15 ½" (20 per box)	0026S
		DN20 ¾" (20 per box)	0027S
		DN25 1" (20 per box)	0028S
STAINLESS STEEL STAND OFF BRACKETS		(20 per box) 0060S	
STAINLESS STEEL ADJUSTABLE STAND OFF BRACKETS		(20 per box) 0080S	
STAINLESS STEEL HANGING BRACKETS		300mm (20 per box) 0059S	
STAINLESS STEEL STAND OFF CLIPS FOR PVC DWV PIPE		DN40 1½" (100)	1691S
		DN50 2" (100)	1692S
		DN90 3½" (50 per box)	1696S
		DN100 4" (50 per box)	1693S
STAINLESS STEEL DWV SADDLE CLIPS FOR PVC DWV PIPE		DN40 1½" (25 per box)	1706S
		DN50 2" (25 per box)	1707S
		DN100 4" (50 per box)	1710S
STAINLESS STEEL DPC STORMWATER CLIPS FOR STORMWATER PIPE		DN90 (20 per box) 1910S	



STAND OFF CLIPS

Abey Industrial Stand Off Clips for PVC pipe, are a 2 piece clip manufactured without welds to help to eliminate the evils of corrosion for 40-150mm pipe sizes. They are easy to position and fit, even with existing pipework to provide a neater looking finished result. Designed without welds to help prevent rust.

Conforms to AS 2887:1993.

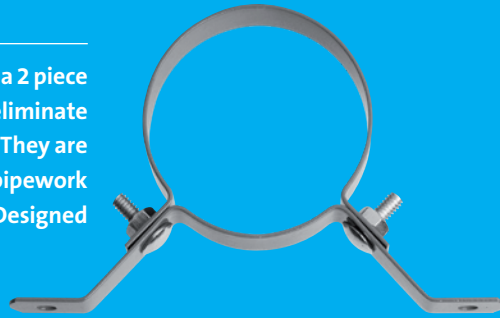

Step 1 – Two part clip for new and retro fit applications.



Step 2 – Position bracket and fasten to wall.



Step 3 – Place pipe into bracket base.



Step 4 – Secure front of the clips with bolt and nuts (supplied).



Step 5 – Fasteners neatly hidden behind pipe.



Australian made, Superior coatings.

PRODUCT DESCRIPTION		CODE
DWV PIPE STAND OFF CLIPS – GALVANISED & POWDER COATED WHITE	DN40 (25 per box)	0120
	DN50 (25 per box)	0121
	DN65 (25 per box)	0122
	DN100 (25 per box)	0124
	DN150 (10 per box)	0125
STORMWATER PIPE STAND OFF CLIPS – GALVANISED & POWDERCOATED WHITE	DN90 (25 per box)	0126

HANGING CLIPS

Faster, non welded for strength and greater corrosion resistance, made from high quality G2-227s galvanised steel to conform to AS/NZ building codes.

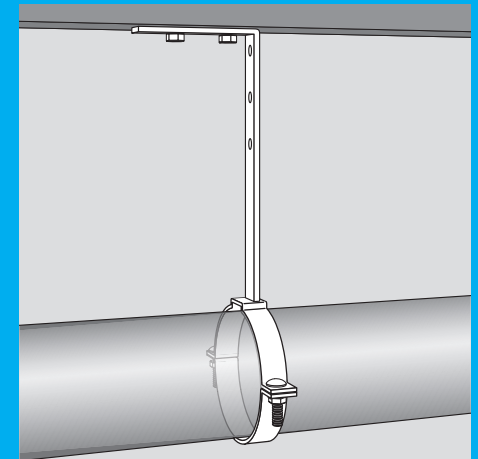
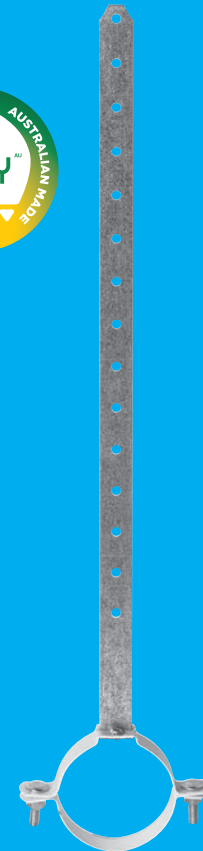

PRODUCT DESCRIPTION	CODE
HANGING CLIPS	
DWV PIPE HANGING CLIPS 450MM SHANK GALVANISED & POWDERCOATED WHITE	
DN40 (20 per box)	0150
DN50 (20 per box)	0151
DN65 (20 per box)	0152
DN80 (20 per box)	0153
DN100 (20 per box)	0154
STORMWATER PIPE HANGING CLIPS 450MM SHANK GALVANISED & POWDERCOATED WHITE	
DN90 (20 per box)	0156
ADJUSTABLE PIPE HANGERS PVC DWV	
DN40 (10 per pack)	5250
DN50 (10 per pack)	5251
DN65 (10 per pack)	5252
DN90 (10 per pack)	5254
DN100 (10 per pack)	5255

INDUSTRIAL BOLTED CLIPS NUT CLIPS

The biggest difference plumbers may notice between the Abey product and imported clips is the welding. While both look similar, Abey's newest nut clips are no longer welded but machine pressed, which means they are stronger, more consistent better quality products, that fight the rust demons. Imported products are often welded by hand making their quality inconsistent. See instructional web video – www.abeytrade.com.au

Abey Industrial Nut Clips are Machine Pressed & are available for PVC DWV Pipe, Copper Pipe, Gal Pipe & HDPE Pipe.

For sizes ranging from 12 – 300mm diameter. A powder coating is applied to the galvanised clip to give extra corrosion protection.



Abey's manufacturing facility showing press stamping of components that is stronger and less corrosive than welding.

INDUSTRIAL BOLTED CLIPS NUT CLIPS

PRODUCT DESCRIPTION		CODE
WELDED NUT CLIP FOR DWV PIPE - GALVANISED & POWDERCOATED WHITE PVC DWV Pipe Nut Clips M10	40mm (25 per box)	5170
	50mm (50 per box)	5171/50
	65mm (50 per box)	5172/50
	80mm (50 per box)	5173/50
	100mm (50 per box)	5174/50
	150mm (25 per box)	5175/25
	225mm (Each)	5280
DWV PIPE NUT CLIPS M12 GALVANISED & POWDERCOATED WHITE	300mm (Each)	5281
	225mm (Each)	5161
WELDED NUT CLIP FOR COPPER PIPE - GALVANISED & POWDERCOATED BROWN Copper Pipe Nut Clips M10	300mm (Each)	5162
	12mm (25 per box)	5165
	18mm (25 per box)	5177
	25mm (25 per box)	5178
	32mm (25 per box)	5179
	40mm (25 per box)	5180
	50mm (25 per box)	5181
	65mm (25 per box)	5182
	75mm (25 per box)	5183
	100mm (25 per box)	5184
200mm (Each)	5163	
COPPER PIPE NUT CLIPS M12 GALVANISED & POWDERCOATED BROWN	150mm (10 per box)	5185
WELDED NUT CLIP FOR HDPE PIPE - GALVANISED & POWDERCOATED BLACK HDPE Pipe Nut Clips M10	40mm (25 per box)	5140
	50mm (25 per box)	5141
	56mm (25 per box)	5142
	63mm (25 per box)	5143
	75mm (25 per box)	5144
	90mm (25 per box)	5145
	110mm (25 per box)	5146
125mm (10 per box)	5131	
HDPE PIPE NUT CLIPS M12 GALVANISED & POWDERCOATED BLACK	160mm (10 per box)	5149
	200mm (Each)	5152
	250mm (Each)	5151
	300mm (Each)	5153



INDUSTRIAL STAND OFF BRACKETS

In line with Abey's continuous product improvement program they are currently phasing out and re-engineering their welded products due to the inherent weakness and corrosion issues associated with welding. Their new Stand Off Bracket is pressed, has no welds, is stronger and offers greater rust resistance and longevity than welded brackets, especially useful in moist and highly corrosive environments. Insist on Abey and avoid the risks of inferior imports.

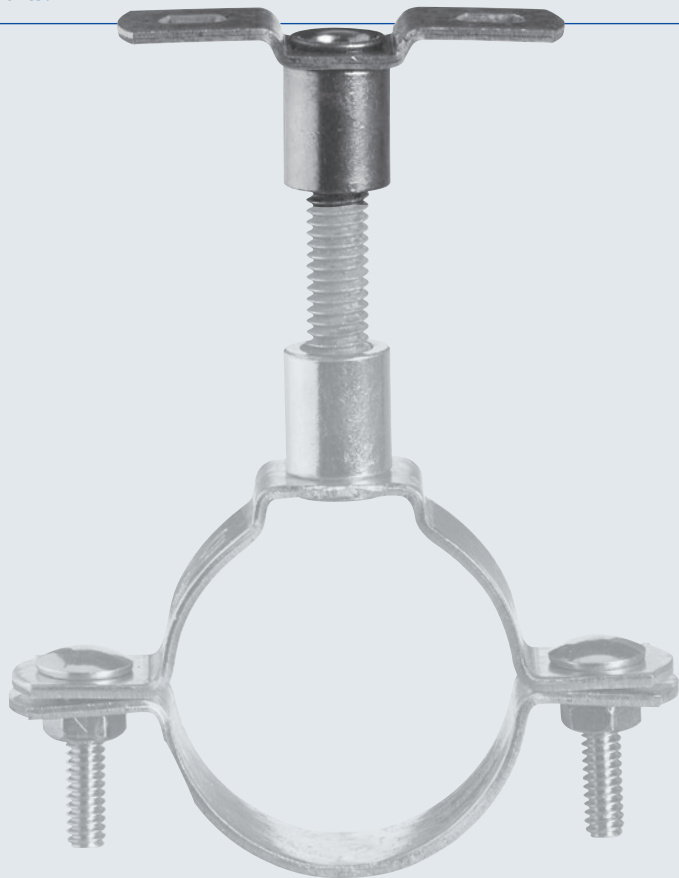

PRODUCT DESCRIPTION

CODE

NUT CLIP STAND OFF BRACKET (PRESSED) M10 (50 per box) 5160/50

INDUSTRIAL ALL THREAD CLIPS

Abey industrial All Thread Clips are rated for industrial applications of up to 1500kg for PVC pipe. There are no welds and they are galvanised and powder coated to eliminate corrosion potential and conform to AS/NZ building codes. They also offer a unique feature for adjustment of pipe fall. See instructional web video – www.abeytrade.com.au



Step 1 – Trim All Thread to required length. Measure and mark off fall line and screw the first locating nut above this position.



Step 2 – Position bracket and swing lower section out of the way and fit pipe.



Step 3 – Secure the lower section with the hi-tensile, zinc plated bolts and nuts (supplied).



Step 4 – Fit remaining pipe and make any minor pipe fall adjustments prior to tightening off.

PRODUCT DESCRIPTION

CODE

PRODUCT DESCRIPTION	CODE
DWV PIPE INDUSTRIAL ALL THREAD CLIPS GALVANISED & POWDERCOATED WHITE	
All Thread PVC Pipe Clips	
DN40 (25 per box)	0170
DN50 (25 per box)	0171
DN65 (25 per box)	0172
DN100 (25 per box)	0174
DN150 (10 per box)	0175

CHANNEL CLIPS



PRODUCT DESCRIPTION

CODE

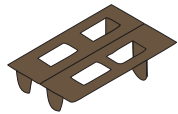

Barrier Strip Included:
Prevents contact between copper pipe and galvanised channel.

CHANNEL CLIP FOR COPPER PIPE NEW
GALVANISED & POWDERCOATED BROWN
Copper Powder Coated



15mm (100 per box)	CC01CTD
20mm (100 per box)	CC03CTD
25mm (100 per box)	CC05CTD
32mm (100 per box)	CC08CTD
40mm (100 per box)	CC10CTD
50mm (50 per box)	CC13CTD
65mm (100 per box)	CC17CTD
80mm (25 per box)	CC21CTD
100mm (25 per box)	CC29CTD
125mm (20 per box)	CC36CTD
150mm (20 per box)	CC39CTD
200mm (20 per box)	CC43CTD
250mm (20 per box)	CC45CTD
300mm (20 per box)	CC47CTD

PRODUCT DESCRIPTION

CODE

CHANNEL CLIP FOR PVC PRESSURE PIPE AND STEEL NEW
Galvanised



15mm (100 per box)	CC04P
20mm (100 per box)	CC06P
25mm (100 per box)	CC09P
32mm (100 per box)	CC11P
40mm (100 per box)	CC12P
50mm (50 per box)	CC16P
65mm (50 per box)	CC20P
80mm (50 per box)	CC25P
100mm (25 per box)	CC33P
125mm (25 per box)	CC38P
150mm (25 per box)	CC41P
250mm (20 per box)	CC46P

COPPER CLIP FOR HDPE PIPE & CONDUIT PIPE NEW
Galvanised



29mm (100 per box)	CC07H
54mm (50 per box)	CC14H
57mm (50 per box)	CC15H
67mm (50 per box)	CC18H
70mm (50 per box)	CC19H
79mm (50 per box)	CC22H
83mm (50 per box)	CC23H
86mm (50 per box)	CC24H
92mm (50 per box)	CC26H
95mm (50 per box)	CC27H
98mm (25 per box)	CC28H
105mm (25 per box)	CC30H
108mm (25 per box)	CC31H
110mm (25 per box)	CC32H
117mm (25 per box)	CC34H
121mm (25 per box)	CC35H
133mm (25 per box)	CC37H
159mm (25 per box)	CC40H
178mm (20 per box)	CC42H
228mm (20 per box)	CC44H

INDUSTRIAL CLIPS ABEY PEAR CLIPS

Abey's Pear Clips are the quickest, safest, best value clips on the market. A quality, easy to use Pear Clip which reduces installation time. Once you've experienced Abey's unique 'snap lock' action, you'll never use ordinary pear clips again!

Abey Pear Clips enable plumbers to hang pipework and make adjustments prior to tightening, reducing many installations to just a one man job. See the installation video.

PRODUCT DESCRIPTION		CODE
PEAR CLIPS TO SUITE PVC DWV Powder Coated White	DN100 (20 per box)	P100C
	DN150 (10 per box)	P150C
	DN250 (10 per box)	P250C



INDUSTRIAL CLIPS ABEY ACOUSTIC PIPE CLIP

Abey have now introduced a range of Acoustic Clips to compliment their already expansive clipping systems. Designed with a patent pending, our new Acoustic Clips performs to the highest levels under laboratory conditions. Tested both here at VIPAC laboratories and in Germany at the prestigious Fraunhofer Institute.



PRODUCT DESCRIPTION		CODE
ACOUSTIC CLIPS TO SUIT PVC PIPE Galvanised	1½" (25 per box)	AC02
	2" (25 per box)	AC04
	2½" (25 per box)	AC06
	3" (25 per box)	AC08
	90mm (25 per box)	AC10
	100mm (25 per box)	AC12



INDUSTRIAL CLIPS VIPAC TEST

The test results from the VIPAC laboratories show comprehensively the superiority of the new Abey Acoustic Clip when compared with four other locally sourced acoustic clips. All clips were subject to the same conditions and the results above on the graph prove conclusively that Abey's clips are superior.

For further detailed explanation of the features & performance of the Abey Acoustic Clip please contact an Abey Sales Representative.

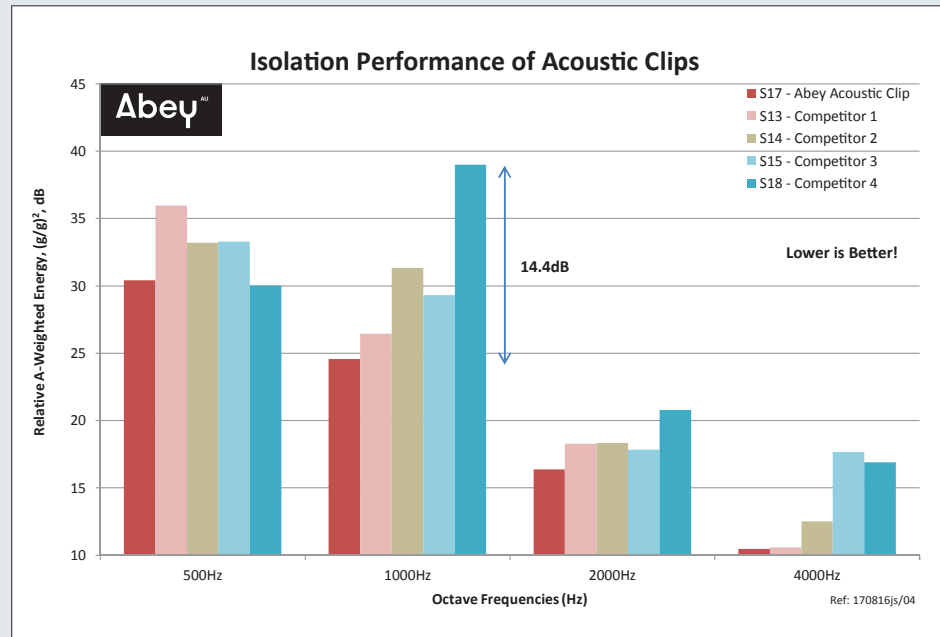

STANDARD PIPE CLIPPING

Abey have for over 60 years been 'The Tradesman's Choice' for quality plumbing products. A proud 100% family owned company, employing over 150 people locally, Abey's streamlined manufacturing facilities produce a huge range of precision engineered products for the building and plumbing industry, that are cost competitive against overseas imports.

For over five decades Abey have set the standards with their extensive range of high quality Australian Made G2-Z275 galvanised steel and powder coated Saddle Clips. Conforming to AS/NZ 3500 3.3.3, they offer the premium protection against electrolysis, corrosion and water hammer.



Quality Materials.



Locally Made = Jobs for Aussies.



National Distribution and Support.



Australian Made Quality.





SADDLE CLIPS

PRODUCT DESCRIPTION	CODE
SADDLE CLIPS FOR GALVANISED PIPE – GALVANISED Saddle Clips for Galvanised Pipe	DN15 ½" BSP (100 per box) 1400
	DN20 ¾" BSP (100 per box) 1401
	DN25 1" BSP (100 per box) 1402
	DN32 1¼" BSP (100 per box) 1403
	DN40 1½" BSP (50 per box) 1404
	DN50 2" BSP (50 per box) 1405
SADDLE CLIPS FOR PVC PRESSURE PIPE – GALVANISED & POWDERCOATED WHITE Saddle Clips for Pressure Pipe	DN15 ½" (100 per box) 1421
	DN20 ¾" (100 per box) 1422
	DN25 1" (100 per box) 1423
	DN32 1¼" (100 per box) 1424
	DN40 1½" (50 per box) 1425
DN50 2" (50 per box) 1426	
SADDLE CLIPS GALVANISED & NYLON COATED FOR COPPER PIPE Saddle Clips CU Coated	DN15 ½" (200 per box) 1467
	DN18 5/8" (200 per box) 1468
	DN20 ¾" (200 per box) 1469
	DN25 1" (200 per box) 1470
	DN32 1¼" (20 per box) 1471
	DN40 1½" (20 per box) 1472
DN50 2" (20 per box) 1473	
DN15 ½" (100 per box) 1664	
SADDLE CLIPS FOR CHROME PIPE Saddle Clips for Chrome Pipe	

SADDLE CLIPS

PRODUCT DESCRIPTION	CODE
COPPER SADDLE CLIPS FOR COPPER PIPE Copper Saddle Clips	DN15 ½" (200 per box) 1684
	DN18 5/8" (200 per box) 1685
	DN20 ¾" (200 per box) 1686
	DN25 1" (200 per box) 1687
POWDER COATED SADDLES FOR PVC DWV PIPE – GALVANISED & POWDERCOATED WHITE PVC DWV Saddle Clips	DN50 2" (100 per box) 1707
	DN65 2½" (50 per box) 1708
	DN80 3" (50 per box) 1709
	DN100 4" (50 per box) 1710
	DN150 6" (10 per box) 1712
	DN40 1½" Stainless Steel (25 per box) 1706S
DN50 2" Stainless Steel (25 per box) 1707S	
DN100 4" Stainless Steel (50 per box) 1710S	
SADDLES FOR PVC DWV PIPE STAND OFF – GALVANISED & POWDERCOATED WHITE PVC DWV Stand Off Clips	DN40 1½" (100) 1691
	DN50 2" (100) 1692
	DN65 2½" (50 per box) 1694
	DN80 3" (50 per box) 1695
	DN90 Stormwater (50 per box) 1696
	DN100 4" (50 per box) 1693
Stainless Steel for PVC DWV PIPE Saddle Clips	DN40 1½" Stainless Steel (25 per box) 1691S
	DN50 2" Stainless Steel (25 per box) 1692S
	DN90 Stormwater Stainless Steel (25 per box) 1696S
	DN100 4" Stainless Steel (50 per box) 1693S
DOWNPIPE CLIPS/SADDLES FOR STORMWATER PIPE	DN80 (20 per box) Galvanised & Powder Coated 1909
	DN90 (50 per box) Galvanised & Powder Coated 1910/50
	DN90 (20 per box) Stainless Steel 1910S
	DN90 (50 per box) Colorbond 1910C

STAINLESS STEEL SADDLE CLIPS

PRODUCT DESCRIPTION	CODE
POWDER COATED SADDLES FOR PVC DWV PIPE – STAINLESS STEEL & POWDERCOATED WHITE PVC DWV Saddle Clips 	DN40 1½" Stainless Steel (25 per box) 17065
	DN50 2" Stainless Steel (25 per box) 17075
	DN100 4" Stainless Steel (50 per box) 17105
SADDLES FOR PVC DWV PIPE STAND OFF – STAINLESS STEEL & POWDERCOATED WHITE PVC DWV Stand Off Clips 	DN40 1½" Stainless Steel (25 per box) 16915
	DN50 2" Stainless Steel (25 per box) 16925
	DN90 3½" Stainless Steel (25 per box) 16965
	DN100 4" Stainless Steel (50 per box) 16935
DOWNPIPE CLIPS/SADDLES FOR STORMWATER PIPE 	DN90 (20 per box) Stainless Steel 19105

MCALPINE PLASTIC PRODUCTS

McAlpine's range of plumbing products provide simple solutions to save you time, money and space. These 'best of breed' products have been selected from the world's best manufacturers to provide you quality plumbing solutions at the right price.



MCALPINE PLASTIC PRODUCTS AIR ADMITTANCE VALVES (VENTAPIPE)

Abey's Ventapipe Air Admittance Valves are for use in above ground drainage systems to enable ventilating pipes to be terminated within the building. Easier, faster installations are gained, negating the need for roof penetrations. Conforms to AS 2887:1993, AS/NZ 4936:2002.

- ✓ Prevents the release of foul air
- ✓ Reduces risk of syphoning
- ✓ Can be used in most internal situations
- ✓ Used in both new and existing systems
- ✓ Allows for greater design flexibility
- ✓ Reduces material and labour costs
- ✓ Rigorously tested
- ✓ Will not unseal



As a Trap Vent

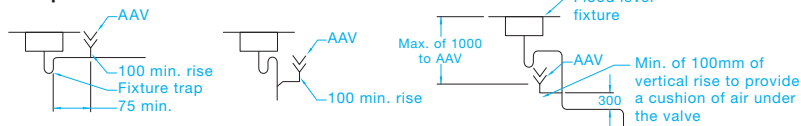

As a Group Vent

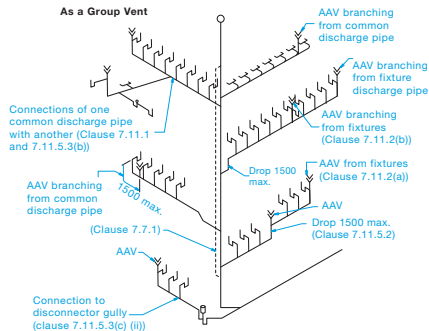

Ventapipe Air Admittance Valve

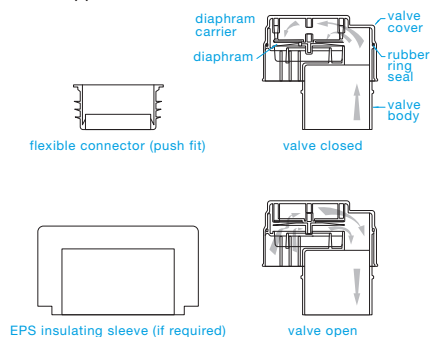

ABEY FANTASTIC PLASTIC PRODUCTS AIR ADMITTANCE VALVES & SELF CLOSING WATERLESS TRAPS

PRODUCT DESCRIPTION		CODE
AIR ADMITTANCE VALVES (AAVS) Air Admittance Valve	40/50mm	VPSFN-1.5-2
Air Admittance Valve	50mm	VP50
Air Admittance Valve	100mm	VP100
ADJUSTABLE S&P TRAPS WITH AV S&P Trap with Air Admittance Valve	40mm	SP40AV
S&P Trap with Air Admittance Valve	50mm	SP50AV
TUBULAR SWIVEL TRAPS 1 ½" Tubular Swivel All One Trap NEW		TP10



MCALPINE PLASTIC PRODUCTS ALL-IN-ONE AAV SPEED TRAP

Can be useful in one off retrofit situations when appliance is over distance from the stack eg powder rooms, butlers pantry, wet bar, etc.

The unique design draws air through the valve and not through the water seal eliminating any gurgling for a quieter discharge



Extended universal dishwasher inlet with 1" BSP thread for easier fitting of outlet hose

Integrated AAV vents internally and eliminates the need for secondary ventilation and additional pipe fabrication

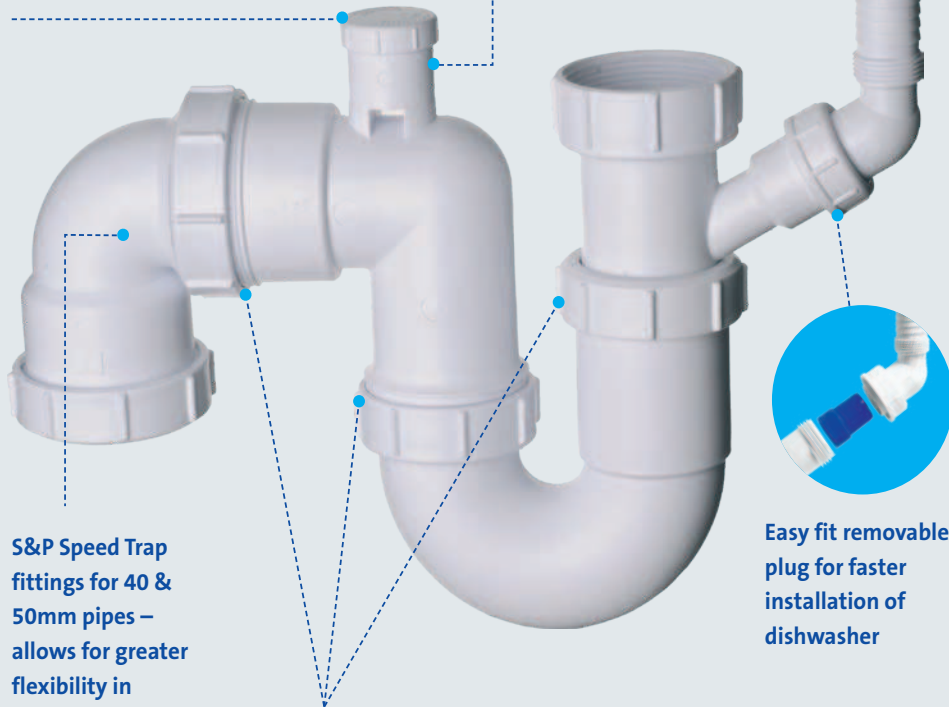









S&P Speed Trap fittings for 40 & 50mm pipes – allows for greater flexibility in

Adjustable fittings provide easy adjustability and watertight results



MCALPINE PLASTIC PRODUCTS BOTTLE TRAPS & SELF-CLOSING WATERLESS TRAP

PRODUCT DESCRIPTION	CODE
Horizontal Waterless Trap NEW 	WV-1-A
BOTTLE TRAPS Reseal Adjustable Bottle Trap 	CP 32-40mm BT40A-CP
Bottle Trap with Anti-syphon Adjustable 	40mm C10AV
Bottle Trap 360mm Pipe 	Chrome WC10 Black WC10-B Brushed Nickel WC10-BN
SELF-CLOSING ONE WAY WATERLESS TRAPS 1 1/2" BSP Inlet and Compression Outlet Self Sealing Trap 	MACVALVE-2
90 degree Bend 1 1/2" Female inlet x 1 1/2" BSP Male Connector to suit MACVALVE-2 	T4U
1 1/2" Universal Inlet & Outlet Self Sealing Trap 	MACVALVE-5
2" Universal Inlet & Outlet Self Sealing Trap 	MACVALVE-20



MCALPINE PLASTIC PRODUCTS WC CONNECTORS

PRODUCT DESCRIPTION		CODE
WC CONNECTORS		WC-CON1
WC Straight Connector		
Offset Connector 20mm		20mm offset 
Offset WC Connector		40mm offset 
Space Saving Pan Bend		



MCALPINE PLASTIC PRODUCTS MACVALVE SELF-CLOSING WATERLESS TRAP

Abey's new Space Saver with Self Closing Waste Valve has been designed for bathroom basins to give you back your valuable vanity space. Bulky ugly waste traps are a thing of the past. Low profile in design the Space Saver Waste valve brings the pipe plumbing straight to the back of your vanity giving you more storage space below the basin cabinet.



SELF-CLOSING WATERLESS TRAP

When installation space is an issue and traditional traps just don't fit, Abey's McAlpine Self Closing, One-Way Waterless Waste Valve is the answer. A relatively low cost solution that eliminates awkward, messy and time consuming fabrication work and can be fitted horizontally or vertically with a one-way flow valve that prevents back flow and seals out odours and gases.

- Can be fitted in horizontal or vertical position.
- MacValve membranes open under water pressure to allow discharge to flow freely and then close to form a seal to prevent foul odour or sewer gas entering the building.
- MacValves offer a solution to working in confined spaces where traditional traps just won't fit.
- MacValves can be used to take the discharge from a pressure relief valve on an unvented domestic hot water storage system.
- MacValves having no water seal can never dry out through evaporation or lack of use of an appliance as the membrane remains sealed.
- MacValves are not recommended for use with shower trays unless there is access for maintenance.



MACVALVE-2 1 1/2" BSP Inlet & Compression Outlet Self Sealing Trap



MACVALVE-5 1 1/2" Universal Inlet & Outlet Self Sealing Trap



MACVALVE-20 2" Universal Inlet & Outlet Self Sealing Trap



T4U 90 degree Bend 1 1/2" Female inlet x 1 1/2" BSP Male Connector to suit Macvalve-2

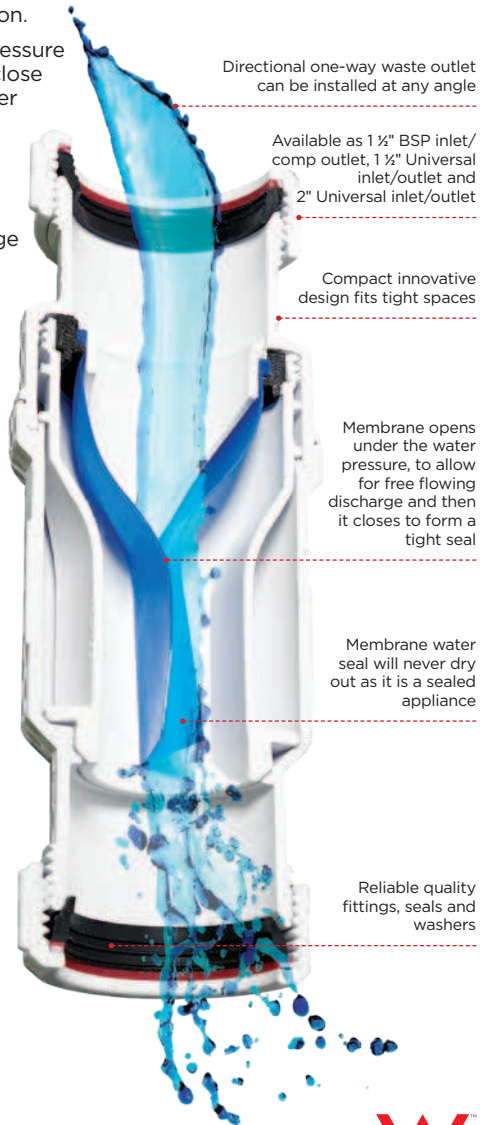

Directional one-way waste outlet can be installed at any angle

Available as 1 1/2" BSP inlet/comp outlet, 1 1/2" Universal inlet/outlet and 2" Universal inlet/outlet

Compact innovative design fits tight spaces

Membrane opens under the water pressure, to allow for free flowing discharge and then it closes to form a tight seal

Membrane water seal will never dry out as it is a sealed appliance

Reliable quality fittings, seals and washers

MACALPINE Drain cleaners must never be used with these products as they will damage the membrane | When installing horizontally, the flow arrow must be in the uppermost position | Maximum water temperature 80°C | PATENT PENDING



NEW

Redback Strapped Knee Pads.

Redbacks® award winning knee pads have been scientifically proven to outperform foam knee pads by Professors at Staffordshire University.

Developing cushioning and protection technology is an exacting science - rightly so, given the considerable stresses everyday work activities such as kneeling, bending and standing place on the human body.

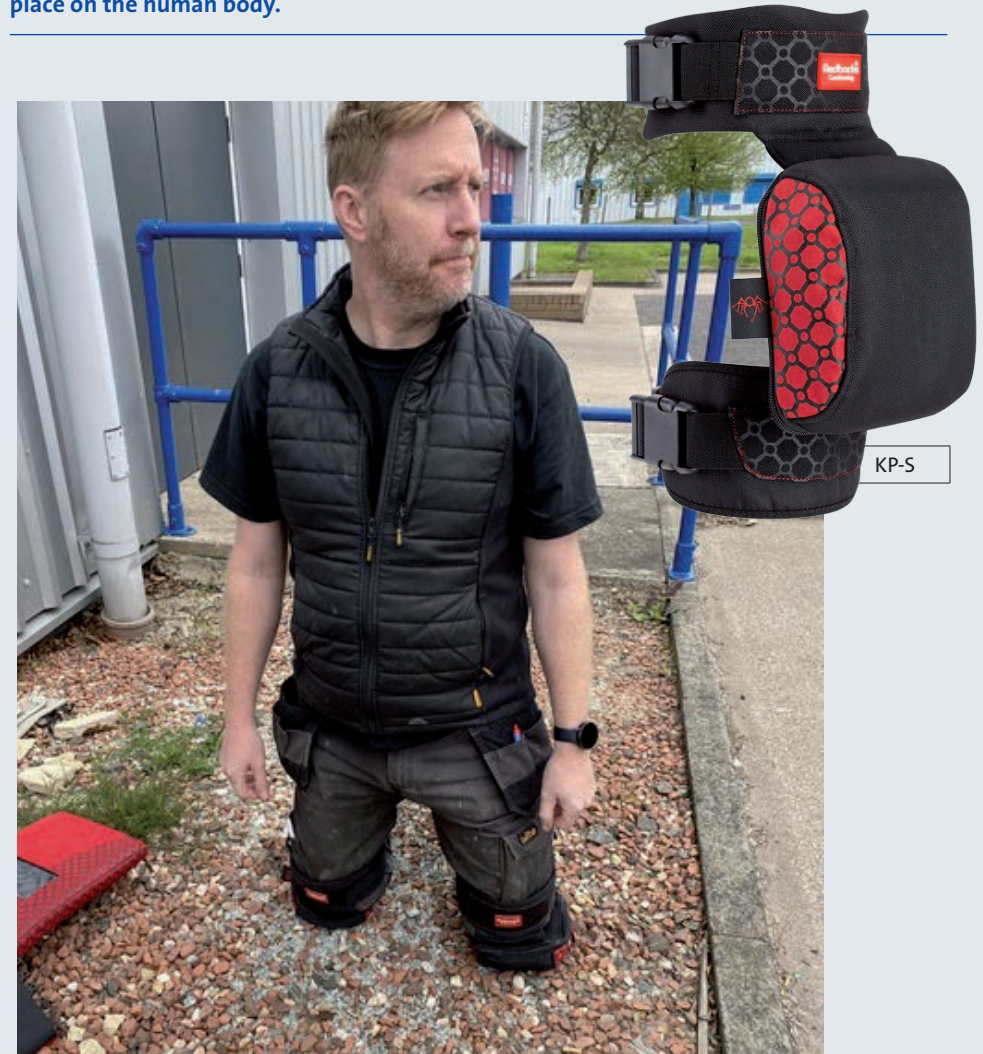

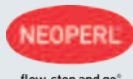

HIGH CLASS EASY HOOKERS

VIRTUALLY EVERY DWELLING IN AUSTRALIA TODAY IS SITTING ON A TICKING TIME BOMB.



Insurance company statistics show that flexible braided pipes were responsible for more than 20% of water damage claims*. But as time moves forward these figures will certainly rise to potentially epidemic proportions as corrosion and product failures increase.

Most water connectors have the potential of failure. It's just a matter of time. Water hoses should be checked every year for corrosion and changed every 5 years or earlier.

SOLUTION...

Abey's Polyamide Hi Class Easy Hookers offer the most advanced solution and use high strength, non-metallic, non-corrosive braiding similar to kevlar material used in bulletproof vests. Because they are not metal they will never rust, even when in extended contact with water-borne chemicals such as chlorine. They are stable and strong, don't kink and best of all they come with an unheard of 15 Year Abey Rust Resistance Warranty.

- Superior strength and corrosion resistant
- 15 Year Abey Rust Resistance Warranty
- Tested and watermark approved
- Easy to fit and flexible
- Higher tensile strength
- Higher working pressure
- New SOFTPEX® Core with excellent mechanical characteristics



The new SOFTPEX® Core

The new SOFTPEX® Core guarantees a mechanical performance superior to EPDM which can release polluting substances such as chlorine, affecting water potability. Other advantages over an EPDM rubber hose include: a longer life with extensive age/stress testing, higher abrasion resistance, higher tensile strength, non-corrosiveness, higher working pressure and 0% failure rate.



Don't wait for disaster to strike! Change over to an Abey Polyamide Hi Class Easy Hooker - the highest protection in its class.



HIGH CLASS EASY HOOKERS

Abey's High Class Easy Hookers are the worlds "Best of Breed" and offer the most advanced solution and use high strength, non-metallic braiding similar to kevlar material used in bulletproof vests. Because they are not metal they won't rust, even when in extended contact with water-borne chemicals such as chlorine. They are stable and strong, don't kink and best of all they come with an unheard of 15 Year Rust Resistance Warranty.

- Manufactured by world-renowned European based company Neoperl.
- Superior strength and corrosion resistant.
- 15 Year Abey Warranty.
- Tested and watermark approved.
- Easy to fit and flexible.
- Higher tensile strength.
- Higher working pressure.
- New SOFTPEX® Core with excellent mechanical characteristics.



PRODUCT DESCRIPTION	CODE
POLYAMIDE HIGH CLASS HOOKERS NEW	
8 x 255mm ½ FL/C	NP2400
8 x 300mm ½ FL/C	NP2401
8 x 450mm ½ FL/C	NP2402
8 x 600mm ½ FL/C	NP2404
8 x 1000mm ½ FL/C	NP2407
POLYAMIDE HIGH CLASS HOOKER SINK/BASIN MIXER TAILS NEW	
Mixer Hose Extension Blue 350mm	NP350B
Mixer Hose Extension Red 350mm	NP350R
POLYAMIDE HIGH CLASS HOOKER ELBOWS NEW	
Elbow Hooker 8 x 225mm	NP2580
Elbow Hooker 8 x 300mm	NP2581
Elbow Hooker 8 x 450mm	NP2582
Elbow Hooker 8 x 600mm	NP2584
POLYAMIDE HIGH CLASS HOOKER EXTENSIONS M&F NEW	
M&F Extensions 150mm (x2)	NME150
M&F Extensions 250mm (x2)	NME250
HIGH CLASS HOOKER FOR BACK INLET CISTERNS NEW	
Cistern Inlet Hooker 8 x 350mm	NP350CI

GENERAL PLUMBING STAINLESS STEEL COVER PLATES

Abey produce a wide range of cover plates to suit most pipe sizes and rises.



GENERAL PLUMBING STAINLESS STEEL COVER PLATES

PRODUCT DESCRIPTION	CODE
COVER PLATES FOR BSP PIPE	
Cover Plates for ½" BSP Pipe Flat (50 per box)	2641/50
Cover Plates for ½" BSP Pipe Flat (250 per box)	2641/250
Cover Plates for BSP Pipe Rise ½" x 9mm (50 per box)	2642/50
Cover Plates for BSP Pipe Rise ½" x 9mm (250 per box)	2642/250
Cover Plates for BSP Pipe Rise ½" x 12mm (10 per bag)	2643/10
Cover Plates for BSP Pipe Rise ½" x 12mm (50 per box)	2643/50
Cover Plates for BSP Pipe Rise ½" x 12mm (250 per box)	2643/250
Cover Plates for BSP Pipe Rise ½" x 15mm (10 per bag)	2644/10
Cover Plates for BSP Pipe Rise ½" x 15mm (50 per box)	2644/50
Cover Plates for BSP Pipe Rise ½" x 15mm (250 per box)	2644/250
Cover Plates for BSP Pipe Rise ½" x 21mm (10 per bag)	2645/10
Cover Plates for BSP Pipe Rise ½" x 21mm (250 per box)	2645/250
Cover Plates for BSP Pipe Flat ¾" (10 per bag)	2673/10
Cover Plates for BSP Pipe Rise ¾" x 9mm (10 per bag)	2674/10
Cover Plates for BSP Pipe Flat 1" (10 per bag)	2675/10
Cover Plates for BSP Pipe Rise 1" x 18mm (10 per bag)	2676/10
Cover Plates for BSP Pipe Flat 1¼" (10 per bag)	2677/10
Cover Plates for BSP Pipe Flat 1½" (10 per bag)	2647/10
Cover Plates for BSP Pipe Rise 1½" x 18mm (10 per bag)	2648/10
Cover Plates for BSP Pipe Flat 2" (10 per bag)	2679/10
Cover Plates for BSP Pipe Rise 2" x 18mm (10 per bag)	2680/10





GENERAL PLUMBING STAINLESS STEEL COVER PLATES

PRODUCT DESCRIPTION	CODE
COVER PLATES FOR COPPER PIPE	
Cover Plates for Copper Pipe Flat ½" (50 per box)	2661/50
Cover Plates for Copper Pipe Rise ½" x 9mm (50 per box)	2662/50
Cover Plates for Copper Pipe Flat ¾" (10 per bag)	2665/10
Cover Plates for Copper Pipe Rise ¾" x 9mm (10 per bag)	2666/10
Cover Plates for Copper Pipe Flat 1" (10 per bag)	2667/10
Cover Plates for Copper Pipe Flat 1¼" (10 per bag)	2669/10
Cover Plates for Copper Pipe Flat 1½" (10 per bag)	2663/10
Cover Plates for Copper Pipe Rise 1½" x 18mm (10 per bag)	2664/10
Cover Plates for Copper Pipe Flat 2" (10 per bag)	2671/10
Cover Plates for Copper Pipe Rise 2" x 18mm (10 per bag)	2672/10
COVER PLATES FOR DWV PIPE – WHITE	
Cover Plates for PVC Pipe White Flat 40mm (10 per bag)	2693/10
Cover Plates for PVC Pipe White Flat 50mm (10 per bag)	2695/10



ROOFING

Abey have a range of Roof Plumbing Products that have been designed and manufactured locally to meet the needs of plumbers, using the best quality products to assure compliance to local building codes and provide long lasting performance.

PRODUCT DESCRIPTION		CODE
DOWNPIPE POPS ZINCALUME ROUND Downpipe Pops 	50mm (20 per box)	1952Z
	65mm (20 per box)	1953Z
	75mm (20 per box)	1944Z
	NEW (Bulk Buy 1000 - price per box of 100)	1944Z/100
	90mm (20 per box)	1955Z
	NEW (Bulk Buy 1000 - price per box of 100)	1955Z/100
	100mm (20 per box)	1946Z
NEW (Bulk Buy 1000 - price per box of 100)	1946Z/100	
DOWNPIPE POPS ZINCALUME SQUARE Downpipe Pops 	100 x 50mm (30 per box)	1958Z
	NEW (Bulk Buy 1000 - price per box of 100)	1958Z/100
	100 x 75mm (30 per box)	1959Z
	NEW (Bulk Buy 1000 - price per box of 100)	1959Z/100
	100 x 100mm (20 per box)	1960Z
ZINC DOWNPIPE CLIPS ROUND Downpipe Clips 	100mm (20 per box)	1916Z
DOWNPIPE CLIPS ZINCALUME SQUARE Downpipe Clips 	100 x 50mm (25 per box)	1918Z
	100 x 75mm (25 per box)	1919Z
DOWNPIPE CLIPS/SADDLES 	75mm (20 per box)	1909
	90mm (50 per box)	1910/50
	90mm (20 per box) Stainless Steel	1910S
	90mm (50 per box) Colorbond	1910C

ROOFING

PRODUCT DESCRIPTION		CODE
SINGLE SKIN FLUE ACCESSORIES – CRIMP BENDS 45 & 90 DEGREE Crimp Bends Galvanised 	75mm (45°)	2623
	75mm (90°)	2633
	100mm (45°)	2624
	100mm (90°)	2634
	125mm (45°)	2625
	125mm (90°)	2635
	150mm (45°)	2626
	150mm (90°)	2636
	200mm (45°)	2627
	200mm (90°)	2637
CHINA HAT COWLS – GALVANISED China Hat Cowls (with bird proofing) 	75mm	2501
	90mm	2502
	100mm	2503
	125mm	2505
	150mm	2507
	175mm	2508
	200mm	2509
	225mm	2510
	250mm	2511
	275mm	2512
RAINHEADS – ZINCALUME Rainheads Z/A 	300mm	2513
	200 x 175 x 200mm	2541
	275 x 175 x 200mm	2542
	400 x 175 x 200mm	2543
	300 x 225 x 225mm	2544
	500 x 225 x 225mm	2545
	450 x 300 x 300mm	2546
500 x 300 x 300mm	2547	

GENERAL GAS FLUEING PRODUCTS

PRODUCT DESCRIPTION		CODE
GAS FLEX FLUE KITS (TWO PLY) Contains 4m of pipe, 1 x cowl, 1 x 900mm solid gal sleeve, 1 x clamp * AGA Approved	75mm	75GF4K
	100mm	100GF4K
	125mm	125GF4K
GAS FLEX COMPONENTRY Abey Gas Flex Flues (Two Ply) Only sold in box Qty	75 x 1500mm (6 per box)	75GF
	100 x 1500mm (6 per box)	100GF
	125 x 1500mm (6 per box)	125GF
GAS FLEX LENGTHS OF 5 METRES TWO PLY NEW Duraconnect Gas Flex x 5m	75 x 5m (2 per box)	75GF/5M
	100 x 5m (1 per box)	100GF/5M
	125 x 5m (1 per box)	125GF/5M
	150 x 5m (2 per box)	150GF/5M
Gas Flex Flue Connectors Only sold in box Qty	To suit 75mm (6 per box)	75FPA
	To suit 100mm (6 per box)	100FPA
	To suit 125mm (6 per box)	125FPA
GAS FLEX COWLS Gas Flex Cowls	To suit 200mm (each)	2063
	To suit 250mm (each)	2064
	To suit 300mm (each)	3306
GAS COWLS SINGLE SKIN Gas Cowl for AC for Chimney Plate	100mm	2101



NB: The above 3 items can only be used in conjunction with each other and are non returnable



GENERAL GAS FLUEING PRODCUTS

PRODUCT DESCRIPTION		CODE	
GAS COWLS SINGLE SKIN Gas Cowls for Galvanised	75mm	2113	
	100mm	2114	
	100mm (10 per box)	2114/10	
	125mm	2115	
	125mm (6 per box)	2115/6	
	150mm	2116	
	180mm	2117	
	200mm	2118	
	225mm	2119	
	250mm	2120	
	300mm	2121	
	350mm	2122	
	400mm	2123	
	450mm	2124	
SINGLE SKIN GAS FLUE ACCESSORIES Galvanised Ceiling Rings	75mm	3401	
	100mm	3402	
	125mm	3403	
	150mm	3404	
	200mm	3406	
	Galvanised Flashing Clips	100mm (15 per box)	2212
	Chimney Plate		2371
	Chimney Terminal Includes Cowl & Plate		2372



ROOFING RANGEHOOD FLUEING KITS & FLUEING PRODUCTS

Hygiene – In many homes kitchen rangehood exhausts are simply vented into the roof cavity. Over time, cooking gasses and oils expelled from a typical rangehood will build up on the surfaces inside the roof creating an unhygienic and unpleasant environment. Abey's Rangehood Flue Kits expel the cooking gasses and odours outside the house.

Fire Safety – The build up of grease and grime over years of cooking has the potential of being a fire hazard with the potential of fire spreading from an ignited cooking pan racing up the greasy rangehood igniting the built up grime. In situations where inferior plastic conduit may have been used, the plastic, if ignited will actually support combustion. Abey's Rangehood Flue Kits are of metal construction and will not support combustion.

Easy Installation – Abey Rangehood Kits contain all components necessary for easy installation. Available in all inclusive kit forms to suit most applications (vertical kits for metal & tile roofs and a horizontal kit for finishing on an external wall).



ROOFING RANGEHOOD FLUEING KITS & FLUEING PRODUCTS

PRODUCT DESCRIPTION		CODE
RANGEHOOD FLUE Airflex	100mm x 3m (12 per box)	100AF3000
	100mm x 3m (66 per box)	100AF3000B
	125mm x 3m (8 per box)	125AF3000
	125mm x 3m (45 per box)	125AF3000B
	150mm x 3m (6 per box)	150AF3000
	150mm x 3m (28 per box)	150AF3000B
	200mm x 3m (4 per box)	200AF3000
	NEW 200mm AIRFLEX X 3m (10)	200AF3000B
RANGEHOOD FLUE KITS – VERTICAL To suit Steel Roof Contains 3m of Airflex, Cowl, Roof Flashings for Steel Roof, Ceiling Ring and 6 Metres of Building Strapping.	125mm	RHVS5
	150mm	RHVS6
	200mm NEW	RHVS8
	125mm	RHVT5
To suit Tile Roof Contains 3m of Airflex, Cowl, Roof Flashing for Tile Roof, Ceiling Ring and 6 Metres of Building Strapping.	150mm	RHVT6
	200mm NEW	RHVT8
	125mm	RHH5
RANGEHOOD FLUE KITS – HORIZONTAL Contains 3m of Airflex, Ceiling Ring and External Wall Vent (Auto Closing).	150mm	RHH6
	200mm NEW	RHH8

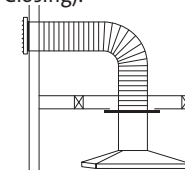
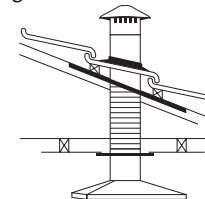
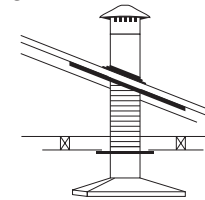

Abey^{AU}

THE TRADIE'S CHOICE

Customer Service 03 9747 7777

Email mail@abey.com.au

Web abeytrade.com.au

 [#abeytrade](https://www.instagram.com/abeytrade)