

# Nero<sup>®</sup> Collection



We take the worry out of  
protecting what's valuable to you.  
Lockwood: no worries<sup>®</sup>

**LOCKWOOD**

**ASSA ABLOY**

**25YEAR**

**MECHANICAL  
WARRANTY**

# Contents



**Entrance**  
Handles  
page 4



**Velocity® Large Rose**  
Element Lever  
page 7



**Velocity® Small Rose**  
Leversets  
page 10



**Velocity® Small Rose**  
Escutcheons  
page 14



**Cavity Sliding**  
Door Lock  
page 16



**FP2**  
Flush Pull  
page 18



**724 Series**  
Slide Arm Door Closer  
page 20



**Nexion® Mechanical**  
Entrance Lockset  
page 22



**Paradigm® Pull Handle**  
Lockset - Deadbolt  
page 26



**Paradigm® 005**  
Double Cylinder Deadbolt  
page 29

# Contents



## Paradigm® 005

Latching

page 33



## Symmetry®

Key in Lever

page 36



## 001 Double

Cylinder Deadlatch

page 39



## Symmetry®

Double Cylinder

page 42



## 100®

Nightlatch

page 44



## 355

Deadlock

page 46

# Entrance Handles



Lockwood Entrance Handles are constructed using the finest materials to incorporate the maximum standards in style, durability, finish and design.

### Style and Variety

Combining fit for purpose with the epitome of style, the Lockwood Entrance Handles offers a high quality solution to the requirements of both residential and commercial markets.

### Packaging For Various Doors

Comes supplied with spigots to suit 10 – 12mm thick glass doors as well as aluminium and timber doors up to 50mm thick.

### Application

Suitable for use on timber or aluminium frame as well as glass doors; making them the ideal choice for commercial, industrial and residential applications.

**Multi Fix - timber, aluminium or glass doors**

### Product Details

#### Materials

Stainless Steel Construction: Constructed of 304 grade stainless steel, suitable for use in external environments

### Standards and Compliance



Disabled Access - AS1428.1

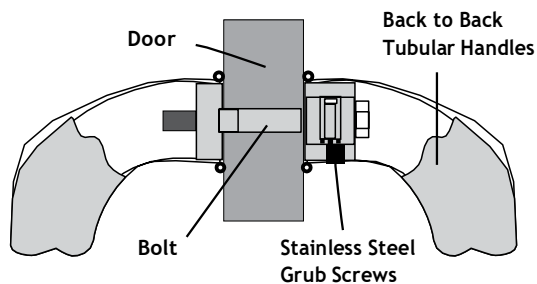

# Entrance Handles

## 141 Series

### Dimensions

	A	B1	B2	C	D	E
141x300MBK	300mm	22mm	40mm	45mm	450mm	25mm
141x600MBK	600mm	22mm	40mm	45mm	750mm	25mm

### Fixing

**Timber** 2 x 80mm M8 Bolts - 8.5mm hole

**Glass** 2 x 40mm M8 Bolts - 13mm hole

 Disabled Accessible AS1428.1

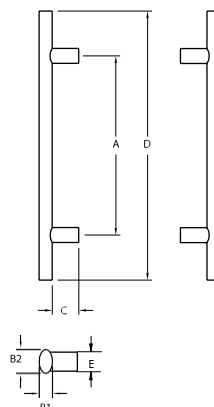

141x600MBK

## 142

### Dimensions

	A	B	C	D	E
142x300MBK	300mm	32mm	45mm	450mm	25mm
142x450MBK	450mm	32mm	45mm	600mm	25mm

### Fixing

**Timber** 2 x 80mm M8 Bolts - 8.5mm hole

**Glass** 2 x 40mm M8 Bolts - 13mm hole

 Disabled Accessible AS1428.1

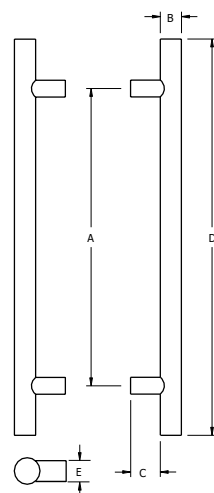

142x450MBK

## 143

### Dimensions

	A	B1	B2	C	D
143x450MBK	450mm	30mm	15mm	35mm	465mm
143x600MBK	600mm	30mm	15mm	35mm	615mm

### Fixing

**Timber** 2 x 62mm M6 Bolts - 8.5mm hole

**Glass** 2 x 32mm M6 Bolts - 13mm hole

 Disabled Accessible AS1428.1

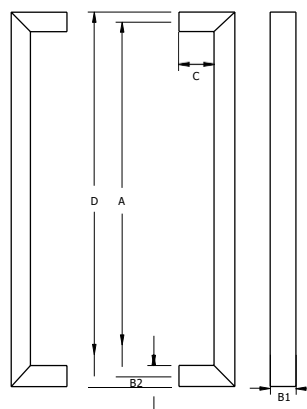

143x600MBK

# Entrance Handles

145

## Dimensions

	A	B	C	D	E
145x225MBK	225mm	25mm	45mm	300mm	19mm

## Fixing

**Timber** 2 x 70mm M8 Bolts - 8.5mm hole

**Glass** 2 x 30mm M8 Bolts - 13mm hole

 Disabled Accessible AS1428.1

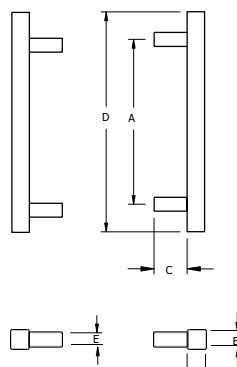

145x225MBK

146

## Dimensions

	A	B	C	D	E	F
146x450MBK	450mm	25mm	60mm	475mm	60mm	25mm
146x600MBK	600mm	25mm	60mm	625mm	60mm	25mm

## Fixing

**Timber** 2 x 80mm M8 Bolts - 8.5mm hole

**Glass** 2 x 40mm M8 Bolts - 13mm hole

 Disabled Accessible AS1428.1

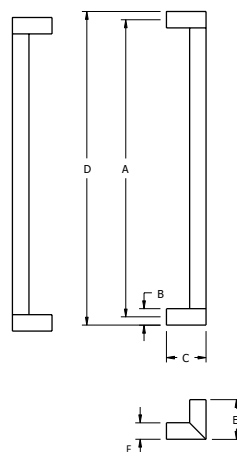

146x600MBK

# Velocity® Series Large Rose Door Furniture



The Velocity Series is a stylish range of door furniture suitable for use in residential dwellings.

Designed to suit common door preparations in the Australian market, Velocity is ideal for both new and retrofit applications.

#### Retrofitable

Fits majority of doors with 54mm hole.

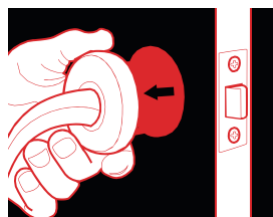

1 Align 2 Twist 3 Tighten



#### Features and Specifications

- All fixings are concealed beneath a removable rose trim providing a crisp and clean presentation desired by the discerning home owner
- Simple twist and tighten fixing method with pre-assembled lever set allows for super easy and fast installation
- The rose fits 50mm or 54mm diameter holes making it suitable for retrofit and common door preparations
- Designed in Australia for the specific needs of the Australian market

#### Product Details

**Rose Dimensions** 63mm by 12.5mm.

**Materials** Solid zinc die-cast with steel rose trims

**Latches** Passage sets are available with a 60mm backset tubular latch. Privacy sets are supplied with a 60mm backset privacy latch which includes an activating pin for the inside of the door and an external emergency release function. The latch is automatically released when the internal handle is operated and is easily adapted for both open in and open out applications. All latches are supplied with industry standard "D" strikes.

**Door Thickness** 32mm to 45mm hinged doors

**Finishes** Matt Black (MBK)

#### Standards and Compliance

**D5** Tested to AS4145.2 2008 for Durability passing D5 - 100,000 cycles.



Tested to AS4145.2 2008 for Neutral Salt Spray, passing C6 - 168 hours.

Not suited to coastal applications

# Velocity® Series Large Rose Door Furniture

## Element™ – Lever 3

<b>Length</b>	122mm
<b>Projection</b>	54.5mm
<b>Finger Clearance</b>	47.5mm

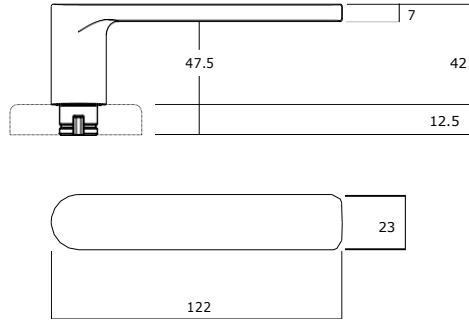

## Passage Leverset

**Part Number** VEL1/L3MBK

## Dummy Lever

**Part Number** VEL3/L3MBK

## Privacy Leverset

**Part Number** VEL2/L3MBK

## Passage Leverset

**Part Number** VEL1/37MBKDP



Disabled Accessible  
AS1428.1

\*Available in Display Pack Only



# Velocity® Series Large Rose Door Furniture

## Privacy Leverset

**Part Number** VEL2/37MBKDP



Disabled Accessible  
AS1428.1

\*Available in Display Pack Only



## Square Rose Passage Trim

**Part Number** VES1-TRIMMBK

\* Pack of 2

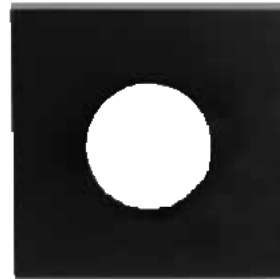

## Square Rose Privacy Trim

**Part Number** VES2-TRIMMBK

\* Pack of 2

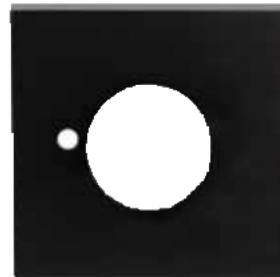

# Velocity® Series Small Rose Door Furniture



The Velocity Small Series is a stylish range of door furniture suitable for both residential and semi-commercial applications. Designed primarily for new installation on timber doors, the range incorporates functionality for use with Mortice Locks in addition to Passage, Privacy and Dummy Levers.

## Installation

Suits door thickness range of 32mm to 45mm.

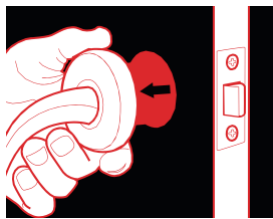

1 **Align**    2 **Twist**    3 **Tighten**



## Features and Specifications

- All fixings are concealed beneath a removable rose trim providing an aesthetically appealing installation
- Simple twist and tighten fixing method with pre-assembled lever set allows for super easy and fast installation
- Choose from two lever designs, the ever popular Element L3 lever and the AS1428.1 compliant Dianella L8 lever
- Accessories include AS1428.1 compliant turn, standard turn and privacy indicating emergency turns
- The 55mm rose suits up to 45mm door thickness commonly used with mortice locks or latches
- Designed in Australia for the specific needs of the Australian market

## Product Details

<b>Rose Dimensions</b>	55mm by 12.5mm - Round Rose 58mm by 12.5mm - Square Rose
<b>Materials</b>	Solid zinc die-cast lever with steel rose trims

<b>Latches</b>	Passage sets are available with a 60mm backset tubular latch. Privacy sets are supplied with a 60mm backset privacy latch which includes a locking pin for the inside of the door and an external emergency release function. The latch is automatically released when the internal handle is operated and is easily adapted for both open in and open out applications. All latches are supplied with industry standard "D" and "T" strikes.
----------------	---

<b>Door Thickness</b>	32mm to 45mm hinged doors
-----------------------	---------------------------

<b>Finishes</b>	Matt Black (MBK)
-----------------	------------------

## Standards and Compliance



Successfully tested up to 2 hours on fire door assemblies in accordance with the Australian Standard AS1905.1 2005 - Part 1: Fire Resistant Doorsets when used with Lockwood Synergy or Selector mortice locks

**D8**

Tested to AS4145.2 2008 for Durability passing D8 - 500,000 cycles



Tested to AS4145.2 2008 for Neutral Salt Spray, passing C6 - 168 hours



AS1428.1 Compliance.  
The range includes AS1428.1 compliant levers and turns

# Velocity® Series Small Rose Door Furniture

## Element™ - Lever 3

Length	122mm
Projection	54.5mm
Finger Clearance	47.5mm

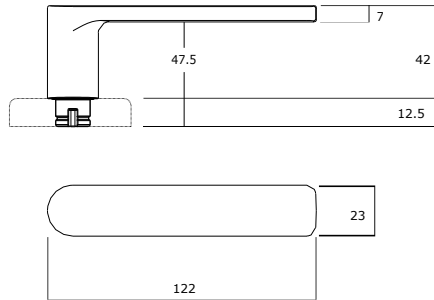

## Mortice Lock Leverset

Part Number	VSR0/L3MBK
-------------	------------

## Passage Leverset

Part Number	VSR1/L3MBK
-------------	------------

## Dummy Lever

Part Number	VSR3/L3MBK
-------------	------------



## Privacy Leverset

Part Number	VSR2/L3MBK
-------------	------------



# Velocity® Series Small Rose Door Furniture

## Dianella™ - Lever 8

**Length** 121mm

**Projection** 51mm

**Finger Clearance** 38mm



Disabled Accessible  
AS1428.1

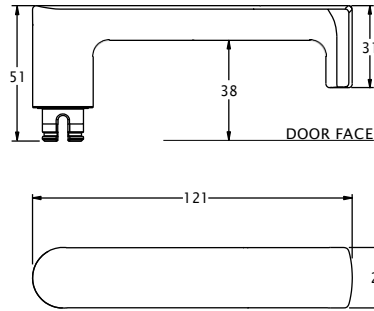

## Mortice Lock Leverset

**Part Number** VSR0/L8MBK

## Passage Leverset

**Part Number** VSR1/L8MBK



## Privacy Leverset

**Part Number** VSR2/L8MBK



# Velocity® Series Small Rose Door Furniture

## Square Rose Passage Trim

**Part Number** VSS1-TRIMMBK

\* Pack of 2

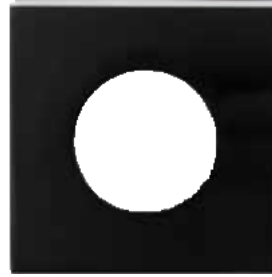

## Square Rose Privacy Trim

**Part Number** VSS2-TRIMMBK

\* Pack of 2

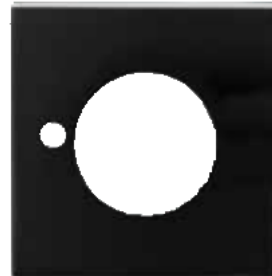

# Velocity® Series Small Rose Door Furniture

## Euro Cylinder Escutcheon

<b>Part Number</b>	VSR5/MBK
<b>Height</b>	55mm
<b>Depth</b>	12.5mm

**Supplied with**  
2x Wood Screws

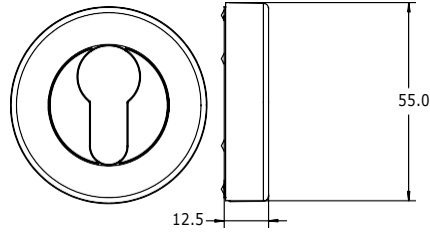

## Oval Cylinder Escutcheon

<b>Part Number</b>	VSR6/MBK
<b>Height</b>	55mm
<b>Depth</b>	12.5mm

**Supplied with**  
2x Wood Screws

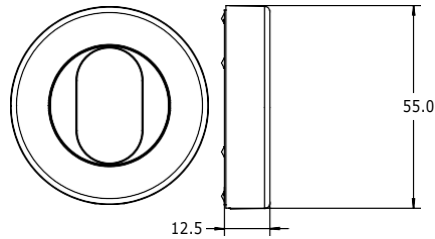

## Standard Turnknob

<b>Part Number</b>	VSR7/MBK
<b>Height</b>	55mm
<b>Depth</b>	12.5mm
<b>Handing</b>	Not required

**Supplied with**  
2x Wood Screws  
1x Short Tail Bar  
1x Medium Tail Bar  
1x Tail Bar Spring  
1x Instructions (1220-321)

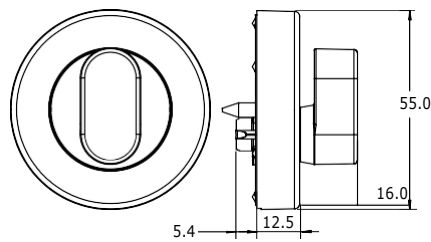

## Privacy Indicating Emergency Turn

<b>Part Number</b>	VSR8/MBK
<b>Height</b>	55mm
<b>Depth</b>	12.5mm

**Supplied with**  
2x Wood Screws  
1x Emergency Tail Bar  
1x Instructions (1220-321)

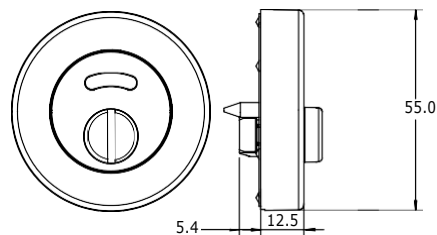

# Velocity® Series Small Rose Door Furniture

## Disabled Accessible Turnknob

<b>Part Number</b>	VSR9/MBK
<b>Height</b>	55mm
<b>Depth</b>	12.5mm
<b>Turn Snib Length</b>	52mm
<b>Handing</b>	Site handable

### Supplied with

- 2x Wood Screws
- 1x Tail Bar (short)
- 1x Tail Bar (medium)
- 1x Tail Bar Spring
- 1x Instructions (1220-321)

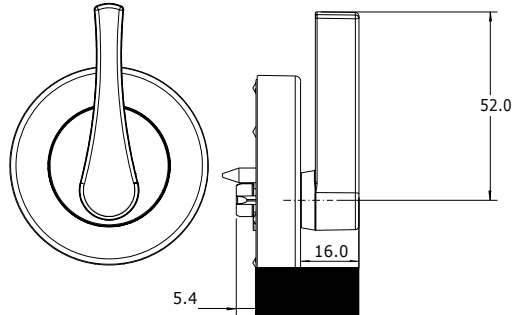

## Square Rose Escutcheon Trim

<b>Part Number</b>	VSS6-TRIMBK
--------------------	-------------

\* Pack of 2

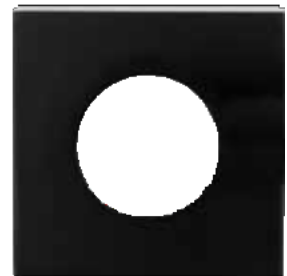

# Cavity Sliding Door Lock



The Lockwood sliding door lock range is possibly the most innovative and aesthetically pleasing lock for a cavity sliding door in Australia. Combining elegance and ease of use, the Lockwood Cavity Sliding Door Lock range is ideal for any home décor and security solution.

Available in entrance, passage and privacy models, it offers the perfect solution for residential bathroom sliding doors.

## Features and Specifications

- Fitted flush against the panel of the sliding door for full recess into the door cavity

### Retractable door pull

Designed after extensive research, the sliding cavity door lock features an innovative retractable door pull which combines style with functionality.

## Product Details

<b>Cross Drill</b>	25mm
<b>Door Thickness</b>	32* to 40mm for timber doors *Requires spacer ring (included)
<b>Finishes</b>	Matt Black (MBK)
<b>Latch Backset</b>	60mm
<b>Prep Hole</b>	54mm
<b>Strike</b>	Box strike or pip strike (passage)
<b>Materials</b>	Furniture plate: Zinc Alloy Bolt: Nickel Plated Zinc (12.4mm projection) Bolt Beak: Stainless Steel Front End Plate: Stainless Steel Retractable Door Pull: Zinc Plated Strike Plate: Stainless Steel Strike Box: Zinc Plated

# Cavity Sliding Door Lock

## 7400 Privacy Set

Part Number	Finish
7400MBKDP	Matt Black

### Outside

Emergency release button opened by coin or screwdriver

### Inside

Locked or unlocked by turn-plate

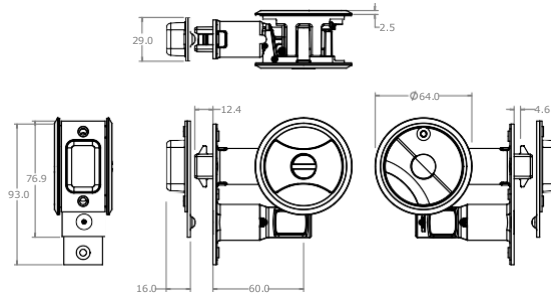

Exterior

Interior

## 7444 Entrance Set

Part Number	Finish
7444MBKDP	Matt Black

### Outside

Locked or unlocked by key

### Inside

Locked or unlocked by turn-plate

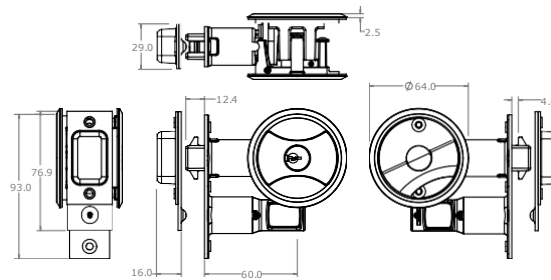

Exterior

Interior

## 7450 Passage Set

Part Number	Finish
7450MBKDP	Matt Black

### Outside

Free to slide door at all times

### Inside

Free to slide door at all times

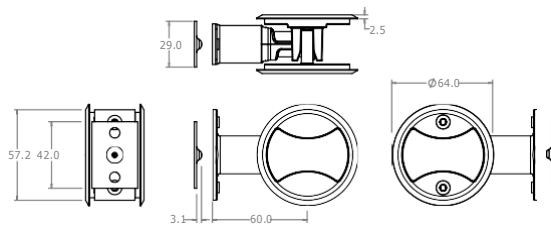

Exterior

Interior

# FP2 Flush Pull



The Lockwood Nero® Flush Pull offers multiple solutions for flush mount door furniture.

## Application

Suited to numerous applications which require the door furniture to be flush with the surface of the door.

## Product Details

<b>Materials</b>	Zinc Stainless Steel
------------------	-------------------------

## Standards and Compliance

**C6**

These products have been successfully tested in accordance with AS 2331-3.1: 2001. Neutral Salt Spray Test (NSS TEST).  
Passing C6 Corrosion Resistance - 168 hours

# FP2 Flush Pull

FP2-150

Dimensions	Packaging	Part Number
150 x 50mm	Trade	FP2-150MBK

## Features and Specifications

- Stainless steel flush pull
- Trade packed, complete with fixing screws

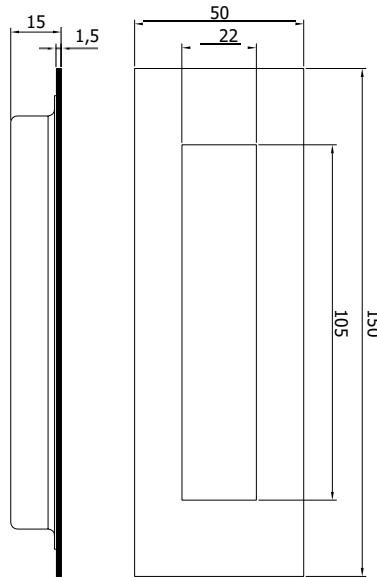

# 724 Series Slide Arm Door Closer



The Lockwood Rack & Pinion Slide Arm Series provides for a cleaner, more aesthetic appearance on the door whilst utilizing the same robust features and benefits of Rack and Pinion functionality.

## Specifications

<b>Power</b>	EN adjustable 2 to 4
<b>Back check (BC)</b>	Adjustable
<b>Hold Open</b>	Adjustable. Hold-open can be set at any angle up to 150° of opening
<b>Handing</b>	Non-handed. Suitable for left or right hand doors
<b>Cover</b>	Clip-on
<b>Materials</b>	Extruded aluminium body manufactured from high-performance silicon alloy
<b>Mechanism</b>	Rack and pinion design
<b>Mounting</b>	Regular, parallel and over-door
<b>Valves</b>	Adjustable closing and latching speed valves with overload protection.

## Standards and Compliance



Tested on fire door assemblies up to 4 hours in accordance with Australian Standard AS1905.1-1997, Part 1: Fire Resistant Doorsets The Lockwood 724SR series closer has been successfully tested upto four hours (depending on type of doorset) on fire door assemblies in accordance with Australian Standard AS1905.1:2005, Part: Fire Resistant Door sets.

Note: Hold open option is not approved on any fire door.

# 724 Series Slide Arm Door Closer

## 724SR Slide Arm Pull Side

Part Number

724SRBLK

Closer installed on pull side of door. This mounting position permits opening of 130°.

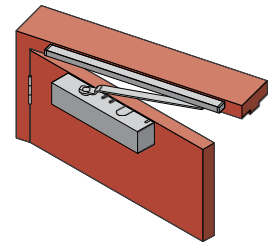
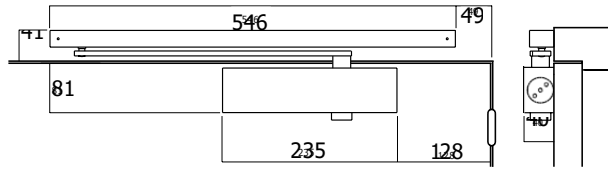

## 7724SR Slide Arm Push Side

Part Number

724SRBLK

Closer installed on push side of door. This mounting position permits opening of 115°.

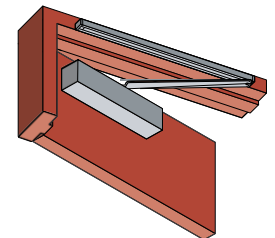
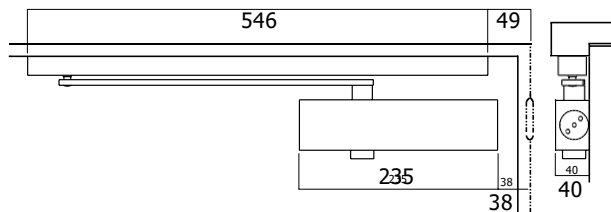

## 7724SR Slide Arm Over Door Mounting Push Side

Part Number

724SRBLK

Closer installed on push side of door and top rail where conditions do not allow parallel mounting. This mounting position permits opening of 115°.

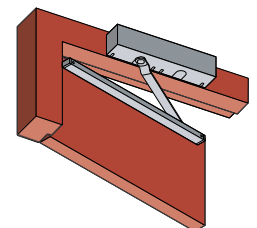
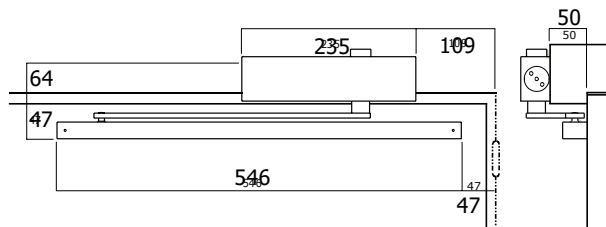

# Nexion® Mechanical Entrance Lockset



The Nexion Entrance Lockset represents the next generation in home security.

Designed and manufactured to the highest standards of quality, the Lockwood Nexion has set the benchmark for safety, security and style. The Nexion offers the ultimate protection for your home and family.

## Features and Specifications

- Three mode security: Secure, Safety and Passage mode provides excellent security without compromising convenience
- LockAlert® indicator shows lock status at a glance
- SafetyRelease™ automatically unlocks the inside handle upon entry to minimise the risk of being locked in
- High security latch
- Box strike with concealed crossgrain door frame strengthening screw
- Can be keyed alike to other Lockwood door locks as well as builder's key systems

## Product Details

<b>Backset</b>	60mm as supplied 70mm optional (order part 530-222SC)
<b>Case</b>	High purity zinc alloy
<b>Door Thickness</b>	35 to 45mm
<b>Finishes</b>	Matt Black (MBK)
<b>Handles</b>	Element Lever 3
<b>Latch</b>	13mm projection brass bolt
<b>Strike</b>	Box strike with concealed crossgrain door frame strengthening screw
<b>Templates</b>	Installation template included
<b>Handing</b>	Adjustable handing by set screw
<b>Cylinder</b>	Internal and external 5 pin tumbler mechanism with 6 pin capability Brass cylinders and brass barrels

## Standards and Compliance



The locksets can be optioned to suit fire door sets with a fire resistance level of up to 1 hour on fire door assemblies in accordance with Australian Standard AS1905.1:2005 Fire Resistant Doorsets. The fire rated option is achieved with a standard Nexion Vision Entrance Lockset and the optional fire rated kit (order NXVFRKIT).

**S7** (Security) Australian Lock Standard (AS4145.2.2008)

**D8** (Durability) Australian Lock Standard (AS4145.2.2008)

**C5** (Corrosion) Australian Lock Standard (AS4145.2.2008)

**CE** CE Approved

**C** C-tick certified

# Nexion® Mechanical Entrance Lockset

## Keying

- Supplied individually keyed with two keys per lock
- 78,000 key combinations
- Key blank KB401B5P

### Restricted Special Keying

Lockwood locks can be keyed to a number of controlled and/or specially keyed systems. These range from legally protected keys to protect against unauthorised duplication, which can also include specially designed key systems such as master key systems, which allow for different levels of mechanical access control.

Please refer to Lockwood Keying Catalogue or contact your local sales office or customer service for specific information.

## Latch Dimensions

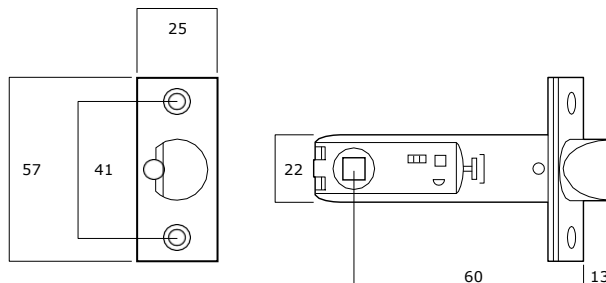

**Kinetic Defence®**  
Bump and pick resistant.



**Deadlatch Bolt**  
13mm projection  
brass bolt.



**SafetyRelease™**  
Minimises the risk of being  
locked in.



**2 Keys Included**  
Can be keyed alike to other  
Lockwood door locks.



**LockAlert®**  
Interior Indicator shows lock  
status at a glance.



**Quick Installation**  
Suitable for door thicknesses  
between 35–45mm.



**Safety Mode**  
Securely locked from outside  
and free from inside.



**Retrofittable**  
Fits majority of doors with  
54mm hole.



**Secure Mode**  
Securely locked from both  
inside and outside. For when  
nobody is home.



**Passage Mode**  
Free to enter from outside  
and free to exit from inside.

# Nexion® Mechanical Entrance Lockset

## Nexion Vision - Double Cylinder



Exterior



Interior

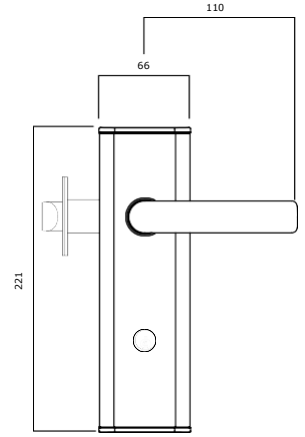
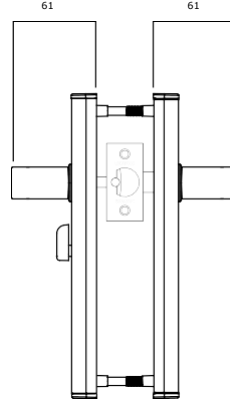
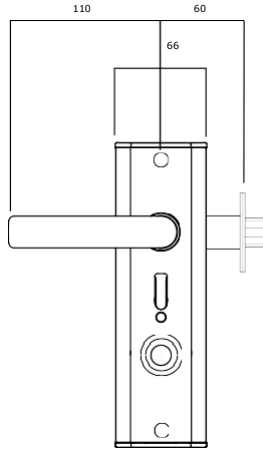

# Nexion® Mechanical Entrance Lockset

## Ordering Procedure

Series	Function	Cylinders	App. Options	Levers	Finish	Keying					
NXV	1	2	1	L3	MBK	-					
Series	Nexion Vision	NXV	Cylinders	Double	2	Levers	Element	L3	Keyed to Differ (Standard)	-	
Function	Mechanical	1	Application Options	Timber Frame Strike*	1	Finish	Matt Black	MBK	Keyed Alike 5 Pins	5KA	
			* Metal Frame T-Strike optional (order part NX8/40SC)					Project Keyed 5 Pins	5PK	Restricted Profile 5 Pins	5RP
									Keyed Alike 6 Pins	6KA	
									Keying	Project Keyed 6 Pins	6PK
									* For Fire Rated Nexion Vision option (order part NXVFRKIT)		

# Paradigm® Pull Handle Lockset - Deadbolt



The Australian designed Paradigm® Pull Handle Lockset expresses superior state-of-the art design featuring a contemporary style that delivers exceptional safety and security.

Suitable for residential, new building and renovation market applications.

The Pull Handle lockset incorporates innovative safety features from the Paradigm 005 Deadbolt and is manufactured with high end 304 grade stainless steel that comes in a Matt Black finish.

## Key Features

- Three function modes with DualSelect® provides combination of convenience and security
- High security cut resistant stainless steel bolt
- High end 304 grade stainless steel and resilient, long-lasting Matt Black finish Pull Handle
- Concealed screw fixings gives a neat and clean appearance
- Safety Release™ automatically unlocks internal knob upon key entry from outside
- LockAlert® indicator shows lock status at a glance

## Restricted Special Keying

Lockwood locks can be keyed to a number of controlled and/or specially keyed systems. These range from legally protected keys to protect against unauthorised duplication, which can also include specially designed key systems such as master key systems, which allow for different levels of mechanical access control.

Please refer to Lockwood Keying Catalogue or contact your local sales office or customer service for specific information.

## Product Details

<b>Dimensions</b>	External handle length - 600mm Internal handle length - 500mm Handle width - 30mm
<b>Backset</b>	60mm-70mm adjustable
<b>Bolt</b>	High security cut resistant
<b>Cylinder</b>	5 pin tumbler mechanism Brass cylinder and brass barrel
<b>Door Thickness</b>	32 - 48mm 32-36mm doors require a spacer (Included)
<b>Finishes</b>	Matt Black (MBK)
<b>Materials</b>	304 Grade Stainless Steel Box strike with concealed crossgrain door frame
<b>Strike</b>	strengthening screw
<b>Magnets</b>	Door Magnets included to hold the door(s) in position when in passage mode (free to enter from outside and free to exit from inside)
<b>Keying</b>	<ul style="list-style-type: none"> <li>• Supplied individually keyed with two keys per lock</li> <li>• 78,000 key combinations</li> <li>• Key blank KB2015P</li> </ul>

## Standards and Compliance

<b>SL8</b>	(Security) Australian Lock Standard (AS4145.2 - 2008)
<b>D8</b>	(Durability) Australian Lock Standard (AS4145.2 - 2008)
<b>C6</b>	(Corrosion) Australian Lock Standard (AS4145.2 - 2008)
<b>K5</b>	(Key Security) Australian Lock Standard (AS4145.2 - 2008)

# Paradigm® Pull Handle Lockset - Deadbolt

## Pull Handle Lockset



Exterior

Interior

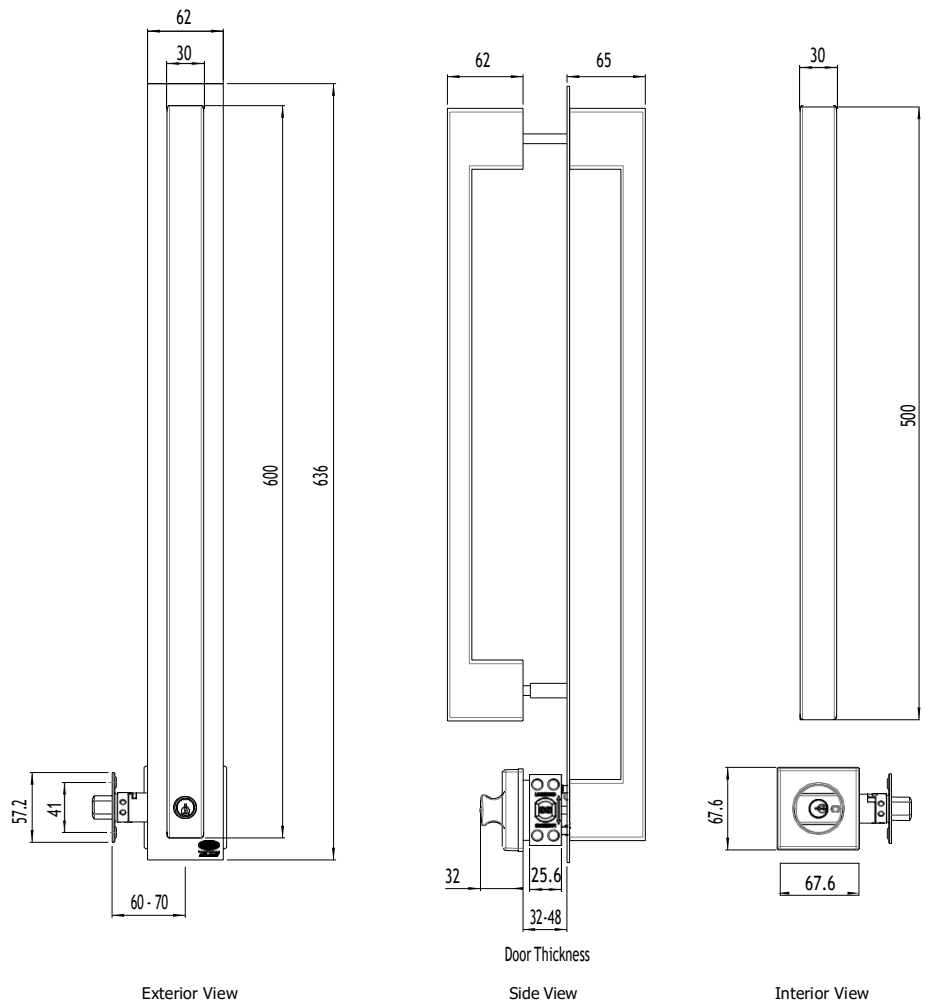

Exterior View

Door Thickness

Side View

Interior View

### Paradigm Pull Handle Lockset

#### Part Number

005/DPHBMBK

### Keying Options

#### Key to differ (standard)

Special Keying-Residential Keyed Alike 5P	5KA
Project Keyed 5P	5PK
Restricted Profile 5P	5RP

# Paradigm® Pull Handle Lockset - Deadbolt



**DualSelect®**  
Turn the key for safety mode. Turn the key further to select secure mode.



**SafetyRelease™**  
Minimises the risk of being locked in.



**Corrosion Resistant**  
Successfully tested in accordance with AS2332.3.1:2001 neutral salt spray test.



**Kinetic Defence®**  
Bump and pick resistant.



**Counterbalance Bolt**  
Proportionally distributes the load between the door and door frame.



**2 Keys Included**  
Can be keyed alike to other Lockwood door locks.



**Door Thickness**  
32mm to 48mm.



**LockAlert®**  
Interior Indicator shows lock status at a glance.



**Safety Mode**  
Securely locked from outside and free from inside.



**Secure Mode**  
Securely locked from both inside and outside. For when nobody is home.



**Passage Mode**  
Free to enter from outside and free to exit from inside.

# Paradigm® 005 Cylinder Deadbolt



The Paradigm® 005 Double Cylinder Deadbolt is the premium security solution with its innovative safety features. The contemporary styling can be combined with any lever or entrance handle to create an elegant security solution, ideal for residential and architectural applications.

## Key Features

- Three function modes with DualSelect® provides combination of convenience and security
- High security cut resistant stainless steel bolt
- Safety Release™ automatically unlocks internal knob upon key entry from outside
- LockAlert® indicator shows lock status at a glance
- Available in round or square rose

## Restricted Special Keying

Lockwood locks can be keyed to a number of controlled and/or specially keyed systems. These range from legally protected keys to protect against unauthorised duplication, which can also include specially designed key systems such as master key systems, which allow for different levels of mechanical access control.

Please refer to Lockwood Keying Catalogue or contact your local sales office or customer service for specific information.

## Retrofittable

Replace your existing Deadbolt. Fits 54mm hole. 60-70mm adjustable backset. 32-48mm door thickness.

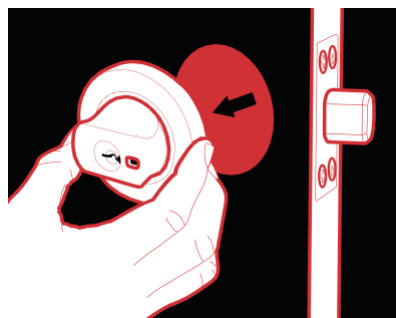

## Product Details

<b>Backset</b>	60 to 70mm adjustable stainless steel bolt
<b>Bolt</b>	High security, cut resistant stainless steel bolt
<b>Cylinder</b>	5 pin tumbler mechanism Brass cylinder and brass barrel 32-48mm
<b>Door Thickness</b>	32-36mm doors require a spacer (Included)
<b>Finishes</b>	Matt Black (MBK)
<b>Keying</b>	Supplied individually keyed with two keys per lock, 78,000 key combinations, Key blank KB401B5P
<b>Materials</b>	High purity zinc alloy
<b>Strike</b>	Box strike with concealed crossgrain door frame strengthening screw

## Standards and Compliance

<b>SL8</b>	(Security) Australian Lock Standard (AS4145.2 - 2008)
<b>D8</b>	(Durability) Australian Lock Standard (AS4145.2 - 2008)
<b>C6</b>	(Corrosion) Australian Lock Standard AS4145.2 - 2008)
<b>K5</b>	(Key Security) Australian Lock Standard AS4145.2 - 2008)

# Paradigm® 005 Cylinder Deadbolt

## Round Rose



Exterior



Interior

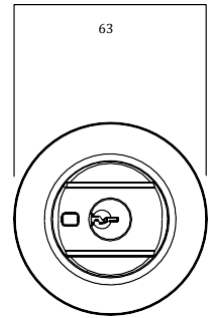
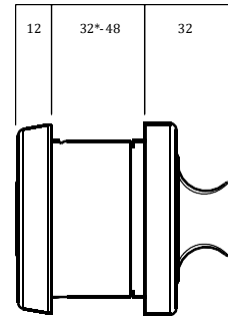
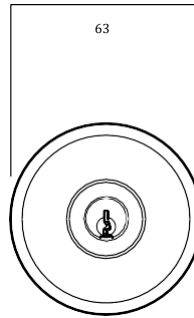

\*32–36mm door thickness requires spacer ring (included)



**Kinetic Defence®**  
Bump and pick resistant.



**Counterbalance Bolt**  
Proportionally distributes the load between the door and door frame.



**DualSelect®**  
Turn the key for safety mode. Turn the key further to select secure mode.



**2 Keys Included**  
Can be keyed alike to other Lockwood door locks.



**SafetyRelease™**  
Minimises the risk of being locked in.



**Retrofitable**  
Replace your existing Deadbolt. Fits 54mm hole. 60-70mm adjustable backset. 32-48mm door thickness.



**Anti-Corrosion**  
Successfully tested in accordance with AS2332.3.1:2001 neutral salt spray test.



**LockAlert™**  
Interior Indicator shows lock status at a glance.



**Safety Mode**  
Securely locked from outside and free from inside.



**Secure Mode**  
Securely locked from both inside and outside. For when nobody is home.



**Passage Mode**  
Free to enter from outside and free to exit from inside.

# Paradigm® 005 Cylinder Deadbolt

## Square Rose



Exterior



Interior

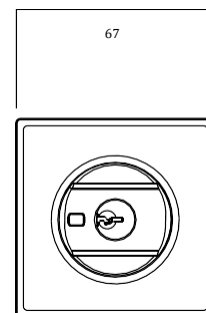
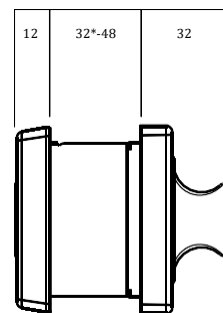
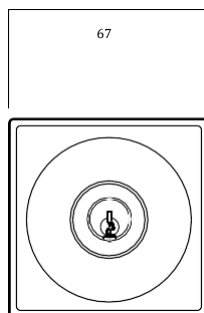

\*32–36mm door thickness requires spacer ring (included)



**Kinetic Defence®**  
Bump and pick resistant.



**Counterbalance Bolt**  
Proportionally distributes the load between the door and door frame.



**DualSelect®**  
Turn the key for safety mode. Turn the key further to select secure mode.



**2 Keys Included**  
Can be keyed alike to other Lockwood door locks.



**SafetyRelease™**  
Minimises the risk of being locked in.



**Retrofitable**  
Replace your existing Deadbolt. Fits 54mm hole. 60-70mm adjustable backset. 32-48mm door thickness.



**Anti-Corrosion**  
Successfully tested in accordance with AS2332.3.1:2001 neutral salt spray test.



**LockAlert®**  
Interior Indicator shows lock status at a glance.



**Safety Mode**  
Securely locked from outside and free from inside.



**Secure Mode**  
Securely locked from both inside and outside. For when nobody is home.



**Passage Mode**  
Free to enter from outside and free to exit from inside.

# Paradigm® 005 Cylinder Deadbolt

## Ordering Procedure

Series	Type	Rose Style	Finish	Packaging	Keying
005	B	1	MBK	DP	
<b>Series</b>		<b>Rose Style</b>		<b>Keying</b>	
Paradigm® 005		Round 1		Universal Pack	DP
		Square 2		Trade Pack	
<b>Type</b>		<b>Finish</b>		<b>Keying Options</b>	
Bolt B		Matt Black MBK		Special Keying-Residential	
				Keyed Alike 5P 5KA	
				Keyed Alike 6P 6KA	
				<b>Packaging</b>	
				Project Keyed 5P 5PK	
				Project Keyed 6P 6PK	
				Restricted Profile 5P 5RP	
* For keying options please contact customer service.					

# Latching Paradigm® 005



The Lockwood Latching Paradigm® 005 is the premium security solution with its innovative safety features. It has a holdback function which keeps the latch in the retracted position when required. The contemporary styling can be combined with any lever or entrance handle to create an elegant security solution, ideal for residential and architectural applications.

## Key Features

- Holdback function keeps the latch in the retracted position when required
- High security cut resistant Stainless Steel latch
- Concealed screw fixings for a neat and clean appearance
- Safety Release™ function minimises the risk of being deadlatched inside

## Restricted Special Keying

Lockwood locks can be keyed to a number of controlled and/or specially keyed systems. These range from legally protected keys to protect against unauthorised duplication, which can also include specially designed key systems such as master key systems, which allow for different levels of mechanical access control.

Please refer to Lockwood Keying Catalogue or contact your local sales office or customer service for specific information.

## Retrofitable

Replace your existing Deadlatch. Fits 54mm hole. 60mm backset. 32-48mm door thickness.

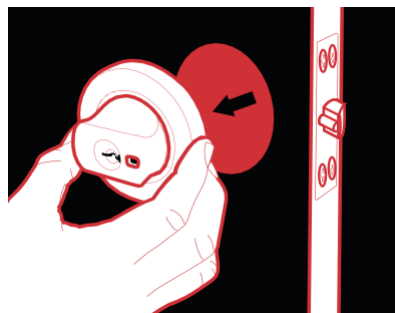

## Product Details

<b>Backset</b>	60 mm stainless steel deadlatch
<b>Latch</b>	High security, cut resistant stainless steel latch
<b>Cylinder</b>	5 pin tumbler mechanism Brass cylinder and brass barrel 32-48mm
<b>Door Thickness</b>	32-36mm doors require a spacer (Included)
<b>Finishes</b>	Matt Black (MBK)
<b>Keying</b>	Supplied individually keyed with two keys per lock, 78,000 key combinations, Key blank KB401B5P
<b>Materials</b>	High purity zinc alloy
<b>Strike</b>	Box strike with concealed crossgrain door frame strengthening screw

# Latching Paradigm® 005

## Round Rose



Exterior



Interior

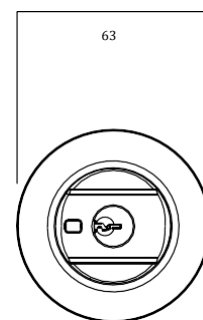
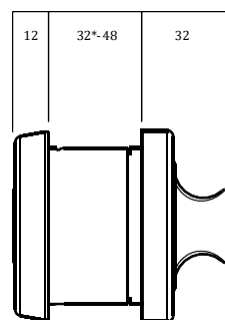
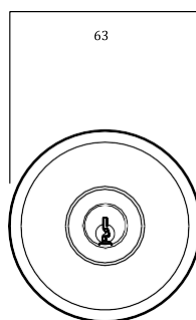

\*32-36mm door thickness requires spacer ring (included)



**Kinetic Defence®**  
Bump and pick resistant.



**Door Thickness**  
32mm-48mm



**SafetyRelease™**  
Minimises the risk of being locked in.



**2 Keys Included**  
Can be keyed alike to other Lockwood door locks.



**Retrofittable**  
Replace your existing Deadlatch.  
Fits 54mm hole. 60mm backset.  
32-48mm door thickness.



**Holdback Mode**  
Keep the latch in the retracted position when required.



**Safety Mode**  
Securely locked from outside and free from inside.



**Secure Mode**  
Securely locked from both inside and outside. For when nobody is home.

# Latching Paradigm® 005

## Ordering Procedure

<b>Series</b> 005	<b>Type</b> L	<b>Rose Style</b> 1	<b>Finish</b> MBK	<b>Packaging</b> DP	<b>Keying</b>
<b>Series</b> Paradigm® Deadbolt 005		<b>Rose Style</b> Round 1		<b>Packaging</b> Universal Pack DP	
<b>Type</b> Latch L		<b>Finish</b> Matt Black MBK		<b>Keying Options</b>	
				Special Keying-Residential Keyed Alike 5P 5KA	
				Keyed Alike 6P 6KA	
				Project Keyed 5P 5PK	
				Project Keyed 6P 6PK	
				Restricted Profile 5P 5RP	
				* For keying options please contact customer service.	

# Symmetry® Key in Lever



The Symmetry door handle range offers builders, developers, specifiers and interior designers a wide selection of product that can be used in any residential application

The Symmetry series is produced to meet the demanding quality and style requirements of the Australian market.

All products are tested in accordance with the security and durability requirements of the Australian Standards.

Along with the Lockwood 25 year Mechanical Warranty all Symmetry door furniture is supplied with a 5 year finish Guarantee with the exception of the Everbrass finish which has a 25 year finish Guarantee.

## Keying

### Standard Keying

- Supplied individually keyed with three keys per lock
- 78,000 key combinations
- Key blank KB401B5P

### Restricted Special Keying

Lockwood locks can be keyed to a number of controlled and/or specially keyed systems. These range from legally protected keys to protect against unauthorised duplication, which can also include specially designed key systems such as master key systems, which allow for different levels of mechanical access control. Please refer to Lockwood Keying Catalogue or contact your local sales office or customer service for specific information.

## Product Details

<b>Backset</b>	60 to 70mm adjustable latch standard
<b>Cylinder</b>	5 pin Lockwood C4 brass cylinder assembly (6 pin compatible)
<b>Functions</b>	Entrance, privacy, passage and dummy available
<b>Handing</b>	Suitable for left and right handed doors
<b>Installation</b>	Easy to install with detailed mounting instructions
<b>Latch</b>	13mm throw
<b>Strike</b>	D-strike with anti-rattle tab as standard

## Symmetry 5 Year Finish Guarantee



Lockwood guarantees to replace Symmetry product if within five years from the proven date of purchase it tarnishes, discolours or corrodes when properly installed and subject to no more than fair wear and tear.

## 1 ONECYL®

The exclusive one cylinder assembly solution 'OneCyl®' has been designed for the entire Lockwood Symmetry Range, which grants the convenience of cylinder interchangeability.

# Symmetry® Key in Lever

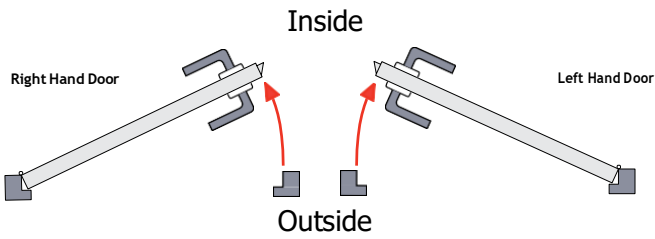

## Symmetry – Element Series

Part Numbers	Function
7550	Entrance
7551	Passage
7552	Privacy
7555	Dummy

## Symmetry – Element Leverset

<b>Type</b>	Tubular Latch
<b>Materials</b>	<b>Key in Lever:</b> Zinc Alloy <b>Chassis:</b> Steel <b>Bolt head:</b> Zinc
<b>Fixing</b>	Horizontal mounting screw fixing
<b>Door Thickness</b>	35–45mm for timber doors
<b>Finish</b>	Matt Black
<b>Packaging</b>	Trade Pack and Display Pack available

# Symmetry® Key in Lever

## Ordering Procedure

Locksets Series	Function	Finish	Packaging	Keying
755	0	SSS		KA
Lockset Series	Function	Finish	Packaging	Keying
Element™ 755	Entrance 0 Passage 1 Privacy 2 Dummy 5	Matt Black MBK	Display Pack DP Trade Pack TP	Special Keying-Residential Keyed Alike 5P 5KA Keyed Alike 6P 6KA Project Keyed 5P 5PK Projected Keyed 6P 6PK Restricted Profile 5P 5RP

# 001 Double Cylinder Deadlatch



The Australian-designed Lockwood 001® Deadlatch offers market-leading performance and reliability for your home.

The 001® Deadlatch features a cut-resistant stainless steel bolt, 11 concealed anchorage points and a door frame strengthener that combine to offer high security protection.

Additional features include a bolt holdback function that allows you to use your door in passage mode.

## Features and Specifications

- Bolt holdback function activated by external key or internal knob
- Can be key locked in holdback position by key from inside
- Can be keyed alike to other Lockwood door locks
- Available in display pack

## Keying

- Supplied individually keyed with two keys per lock
- 78,000 key combinations
- Key blank KB401B5P

## Restricted Special Keying

Lockwood locks can be keyed to a number of controlled and/or specially keyed systems. These range from legally protected keys to protect against unauthorised duplication, which can also include specially designed key systems such as master key systems, which allow for different levels of mechanical access control.

Please refer to Lockwood Keying Catalogue or contact your local sales office or customer service for specific information.

## Retrofitable

Replace your existing 001 Deadlatch.

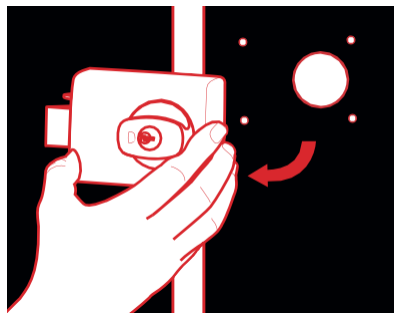

## Product Details

Backset	60mm
Case	High purity zinc alloy
Cylinders	Internal and external 5 pin tumbler mechanism. Brass cylinders and brass barrels.
Door Thickness	30 - 45mm
Finish	Matt Black (MBK)
Latch	Stainless steel 18mm projection
Packers	3mm thick packer plates are available, these packers are installed under lock body to align lock body with face of jamb

## Standards and Compliance

Conforms to Australian Standard (AS4145.2-2008 S,7D8C6)

# 001 Double Cylinder Deadlatch

## Double Cylinder with Knob

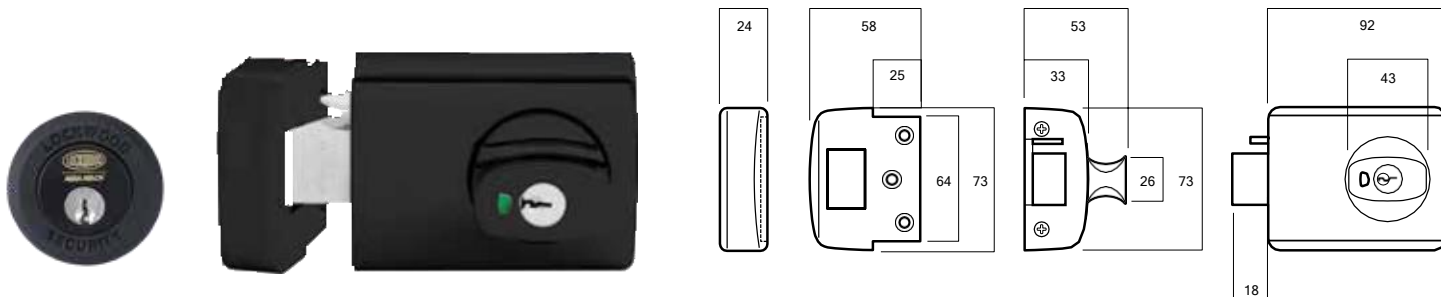

Exterior Cylinder

Interior



**Kinetic Defence®**  
Bump and pick resistant.



**2 Keys Included**  
Can be keyed alike to other Lockwood door locks.



**SafetyRelease™**  
Minimises the risk of being locked in.



**Retrofitable**  
Replace your existing 001 Deadlatch.



**LockAlert®**  
Interior Indicator shows lock status at a glance.



**Safety Mode**  
Securely locked from outside and free from inside.



**Secure Mode**  
Securely locked from both inside and outside. For when nobody is home.



**Passage Mode**  
Free to enter from outside and free to exit from inside.



**Deadlatch Bolt**  
Stainless steel 18mm projection.

# 001 Double Cylinder Deadlatch

## 001 - Knob with Open In Strike - Single Pack

Part Number	Finish
001-1K1MBKDP	Matt Black
001-1K1MBK	Matt Black

Suitable for INWARD opening timber framed doors.

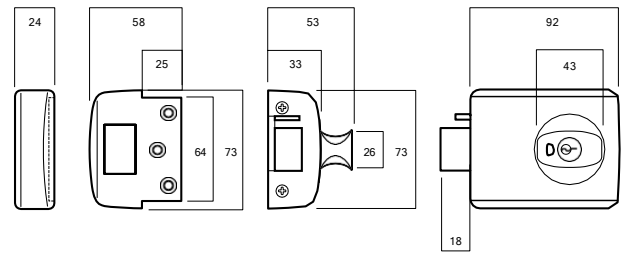

## 001 - Knob with Metal Frame Strike - Single Pack

Finish	Trade Pack
Satin Chrome Pearl	001-3K1SP
Matt Black	001-3K1MBK

Suitable for INWARD opening metal framed doors.

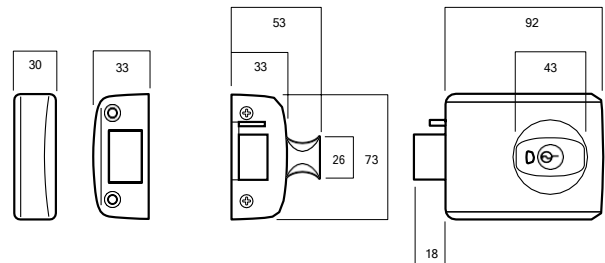

# Symmetry® 7107 Double Cylinder Deadbolt



The Symmetry general purpose Deadbolts are standard security products that should be fitted with a Key in Knob or Key in Lever lockset for added safety and security.

## Keying

- Supplied individually keyed with two keys per lock
- 78,000 key combinations
- Key blank KB401B5P

## Restricted Special Keying

Lockwood locks can be keyed to a number of controlled and/or specially keyed systems. These range from legally protected keys to protect against unauthorised duplication, which can also include specially designed key systems such as master key systems, which allow for different levels of mechanical access control.

Please refer to Lockwood Keying Catalogue or contact your local sales office or customer service for specific information.

## Bolt Dimensions

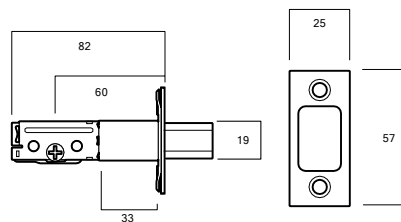

## Retrofitable

Replace your existing Deadbolt. Fits 54mm hole. 60-70mm adjustable backset. 31-45mm door thickness.

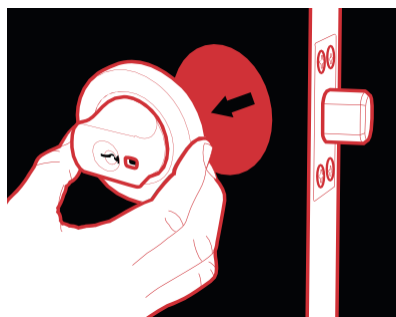

## Bolt

Solid brass bolt with 25mm projection. Hardened insert in locking bolt

## Cylinder

The one cylinder assembly solution "OneCyl®" has been designed for the Lockwood Symmetry Range, which grants the convenience of cylinder interchangeability. C4 brass cylinder assembly (6 pin compatible)

## Product Details

**Backset** 60mm to 70mm adjustable bolt

# Symmetry® 7107 Double Cylinder Deadbolt

## Double Cylinder

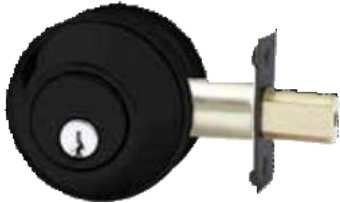

Exterior

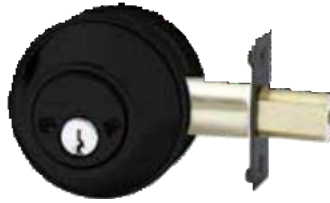

Interior

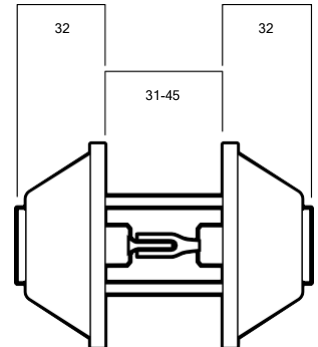
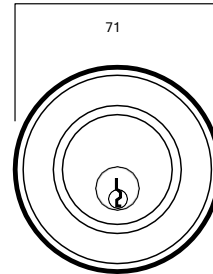

**Kinetic Defence®**  
Bump and pick resistant.



**2 Keys Included**  
Can be keyed alike to other  
Lockwood door locks.



**Retrofitable**  
Replace your existing Deadbolt. Fits  
54mm hole. 60-70mm adjustable  
backset. 31-45mm door thickness.

### ONECYL Cylinder Solution

Part Number	Finish
7107MBKDP	Matt Black
7107MBK	Matt Black

### Product Details

<b>Door Thickness</b>	31mm to 45mm *31 to 41mm requires spacer ring (included)
<b>Finish</b>	Matt Black (MBK)
<b>Handing</b>	Suits left or right hand opening doors
<b>Keying</b>	Operated by key from both inside and outside

# 100 Nightlatch



General purpose nightlatch.

## Features and Specifications

- Opened by key from outside and by turn knob inside
- Bolt may be held back by turning knob in clockwise direction

## Keying

- Supplied individually keyed with two keys per lock
- 78,000 key combinations
- Key blank KB401B5P

## Restricted Special Keying

Lockwood locks can be keyed to a number of controlled and/or specially keyed systems. These range from legally protected keys to protect against unauthorised duplication, which can also include specially designed key systems such as master key systems, which allow for different levels of mechanical access control.

Please refer to Lockwood Keying Catalogue or contact your local sales office or customer service for specific information.

## Product Details

<b>Backset</b>	60mm
<b>Case</b>	High purity zinc alloy. 92mm wide, 64mm high, 43mm projection
<b>Cylinder</b>	5 pin tumbler mechanism Brass cylinder and brass barrel
<b>Door Thickness</b>	28 – 45mm
<b>Latch</b>	Brass. Reversible. 13mm projection Lock Body : Matt Black (MBK)
<b>Finish</b>	External Cylinder: Chrome Plate (CP)

# 100 Nightlatch

100



Exterior Cylinder



Interior

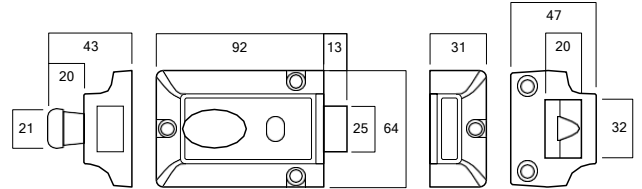

## 100 Nightlatch with Open In Strike

**Finish**                      **Display Pack**

Chrome Plate Cylinder      100MBKDP

# 355 Double Cylinder Deadlock



The premium security features provided by the 355 Deadlock make it an ideal lockset for both domestic and commercial applications.

Opened by key from outside and by turn knob from inside when free. Internal key locks or unlocks turn knob.

## Features and Specifications

- Suitable for hinged and some sliding doors
- Lockable turn knob with inbuilt clutching device to resist wrench attack
- Strong interlocking case and mounting plate to resist jemmy and hammer attack
- Concealed fixing
- Positive deadlocking action
- The mechanism and the design are protected by Australian and International Patents and Design Registrations

## Keying

- Supplied individually keyed with two keys per lock
- 78,000 key combinations
- Key blank KB401B5P

## Restricted Special Keying

Lockwood locks can be keyed to a number of controlled and/or specially keyed systems. These range from legally protected keys to protect against unauthorised duplication, which can also include specially designed key systems such as master key systems, which allow for different levels of mechanical access control.

Please refer to Lockwood Keying Catalogue or contact your local sales office or customer service for specific information.

## Product Details

<b>Backset</b>	60mm
<b>Bolt</b>	Stainless steel
<b>Case</b>	Thick walled, high purity zinc alloy casting
<b>Case Retainer Plate and Operating Mechanism</b>	Solid pressed steel and diecast. Zinc components.
<b>Cylinders</b>	Internal and external 5 pin tumbler mechanism. Brass cylinders and brass barrels.
<b>Door Thickness</b>	30 - 45mm
<b>Finish*</b>	Matt Black (MBK)
<b>Mounting Plate and Strike</b>	Pressed steel
<b>Packers</b>	3mm thick packing plates installed under lock body to align lock body with face of jamb
<b>Strike Conversion Plate</b>	A strike conversion plate is required where the strike is to be installed in place of an existing flange strike

\*Refer to next page for product range

## Standards and Compliance

Conforms to Australian Standard (AS4145.2 - 2008 | S,7D8C6)

# 355 Double Cylinder Deadlock

## Double Cylinder with Knob



Exterior Cylinder



Interior

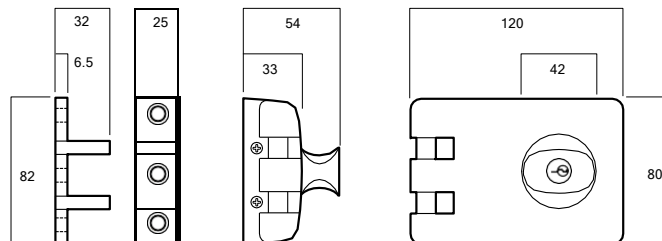

**Kinetic Defence®**  
Bump and pick resistant.



**2 Keys Included**  
Can be keyed alike to other  
Lockwood door locks.



**Retrofitable**  
Replace your existing  
001 Deadlatch.

### 355 Double Cylinder Deadlock

Finish	Trade Pack	Display Pack
Matt Black	—	355-NMBKDP
Matt Black	355-NMBK	—

# NERO<sup>®</sup>

## COLLECTION



### Master the Mood with Lockwood

*The Lockwood Nero Collection provides a sensuous quality that complements contemporary décor; adding a defining design element to any space.*



ASSA ABLOY

Lockwood is the leading brand in the Australian locking industry. With an established reputation for high quality products, this iconic brand provides a wide range of locking solutions to residential housing, commercial, semi-commercial, building and industrial application markets. Lockwood is supported by an extensive distribution and after-sales support network. Our customers include retailers, architects, trade and industrial personnel, locksmiths and security dealers.

ASSA ABLOY is the global leader in door opening solutions, dedicated to satisfying end-user needs for security, safety and convenience.

ASSA ABLOY is represented in all major regions, in both mature and emerging markets, with leading positions in Australia, Europe and North America.



#### The Lockwood 25 Year Mechanical Warranty

Our belief that we manufacture the finest premium products available in today's market place is backed by the Lockwood 25 Year Mechanical Warranty, ensuring that Lockwood continues to keep Australians safe by delivering security and peace of mind.

For warranty terms and conditions, please visit [www.lockweb.com.au](http://www.lockweb.com.au) or call **1300WARRANTY**

#### Disclaimer

Whilst every effort has been made to ensure that the information (including product images and drawings) contained in this brochure is accurate at the time of publication, ASSA ABLOY Australia Pty Limited ("ASSA ABLOY") recommends that you consult ASSA ABLOY or its agents prior to placing an order to ascertain current information on specific products, as ASSA ABLOY reserves the right to make changes without notice. ASSA ABLOY will not be liable for any injury, loss or damage whatsoever, arising from any errors or omissions in the information contained in the brochure or arising from the use or application of the information contained herein. © 2024 copyright by ASSA ABLOY All rights reserved