

# Synergy Mortice Locks



We take the worry out of  
protecting what's valuable to you.  
Lockwood: no worries®

**LOCKWOOD**

**ASSA ABLOY**

**25YEAR**

**MECHANICAL  
WARRANTY**

# Contents



## Synergy 3570 Series

Standard Backset

page 4



## Synergy 3570

Nightlatches

page 7



## Synergy 3571

Deadbolts

page 10



## Synergy 3572

Vestibule Locks

page 14



## Synergy 3573

Sliding Door Deadbolt

page 22



## Synergy 3574

Combination Latches

page 26



## Synergy 3577

Dual Entry

page 31



## Synergy 3578

Holdback Deadlatches

page 34



## Synergy 3579 Series

Mortice Locks and Deadbolts

page 37



## 3540 Swing Bolt

Short Backset  
Mortice Deadbolts

page 44



## 3541 Hook Bolt

Short Backset Mortice Sliding  
Door Lock

page 50



## 3542 Swing Bolt

Short Backset Mortice  
Deadbolts

page 53



### 3540 Series Turn Options

Short Backset Mortice  
Deadbolts and Sliding Door  
Locks  
page 56



### 3540 Series Accessories

Short Backset Mortice  
Deadbolts and Sliding Door  
Locks  
page 58



# Synergy 3570 Series Mortice Locks

# Synergy 3570 Series Cylinder Mortice Locks

## Application

A wide range of security cylinder mortice locks and latches suitable for heavy duty use in industrial and commercial buildings, institutions, clubs, schools, hospitals, hotels and similar buildings.

## Features and Specifications

Synergy Series Cylinder Mortice Locks are made from quality materials to meet high durability and strength requirements.

### Case and Cover Plates

- High purity zinc alloy material cases and stainless steel cover plates
- Brass plates provided for plated finishes available

### Backset

- 60mm standard backset
- Extended backsets 89 and 127mm are available (Refer to Ordering Procedure)

### Latchbolts

Latchbolts are 15mm, stainless steel. Deadlatching is achieved by an auxiliary stainless steel latchbolt. This auxiliary bolt retracts when the main latchbolt is withdrawn when the door is closed.

### Deadbolts

Deadbolts are 19mm, stainless steel.

### Springs

High grade spring steel material, corrosion protected.

### Cylinder Retaining Pin

Hard-drawn spring steel wire, corrosion protected.

### Door Thickness

- Synergy Series locks - 32mm to 50mm
- 3579 Series SCEC Locks - 35.50mm

Components to facilitate use on suit thicker doors are available on application.

## Door Clearance

To ensure correct functioning of the deadlatching mechanism and security for all locks, the clearance between the door and the frame should be 3mm. The deadlatching will operate up to 8mm door clearance, however door clearances over 5mm are not recommended.

## Aluminium Doors

Aluminium door accessory packs and aluminium fix locks are available upon request. Specify SP3570-419 for mounting tabs accessory pack.

## Security

All Synergy Series Cylinder Mortice Locks conform with Level S7 (Physical Security) Australian Lock Standard (AS-4145.2008). Level S8 (Physical Security) is available upon request.

## Durability

All Synergy Series Cylinder Mortice Locks conform with level D8 (Durability) Australian Lock Standard (AS 4145.2008).

## Fire Rating

Lockwood Synergy Series Mortice Locks have been successfully tested up to four hours (depending on type of doorset) on fire door assemblies in accordance with Australian Standard AS 1905.1-2005, Part 1: Fire Resistant Doorsets.

## Cylinder

Bump resistant five pin tumbler mechanism. Standard Lockwood oval shaped brass cylinders and brass barrels.

Functions require the use of different cams and adaptors.

## Keying

### Standard Keying

- Supplied individually keyed with two keys per lock
- 78000 key combinations

## Restricted Special Keying

Lockwood locks can be keyed to a number of controlled and/or specially keyed systems. These range from legally protected keys to protect against unauthorised duplication and can also include specially designed keying systems such as master key systems. This allows for different levels of mechanical access control.

Please refer to [assaabloy.com.au](http://assaabloy.com.au) for keying systems or contact your local sales office or customer service for specific information.

## Standard Finishes

Satin Chrome Brushed	SC
Chrome Plate	CP
Polished Brass	PB

## Extended Cylinders

Modular Cylinder Extensions are available for thicker doors.

## Rebate

Rebate kits to suit 13mm standard rebate are available.

## Electric Strikes

Lockwood Synergy Series Mortice Locks are compatible with most electric strikes. Refer to [assaabloy.com.au](http://assaabloy.com.au) for further details.

 **HIGH SECURITY**

 **DURABILITY**

 **FIRE RATED**

# 3570 Series Standard Backset

## 1. Hub Selection

A patent protected cam operated hub setting mechanism accessible through the lock body from the outside.

## 2. Latch Bolt

Reversible for both left and right hand doors opening in or opening out without disassembly.

Standard deadlatch configuration, except for passage latch function.

Separate auxiliary bolt moves into lock case simultaneously with latch bolt.

Bolt – stainless steel fire rated to 4 hours as standard. Electric strike compatible.

## 3. Strike

Universal stainless steel strike suitable for 4 hour fire rating applications.

## 4. Door Thickness

Standard applications 32 to 50mm.

## 5. Backsets

60mm standard, 89mm and 127mm available.

## 6. Cylinder/Adaptor Retention

"Slip Pin" Cylinder/Adaptor fixing method, which allows attachment to the case by inserting a non-threaded cylindrical pin through the front of the lock case.

## 7. Multi-Function Lock

Lock is designed to significantly reduce stock line items.

## 8. Case Assembly

High purity zinc alloy case and backplate.

## 9. Cylinder Assembly

Five pin tumbler mechanism. Standard Lockwood oval shaped, brass cylinders and brass barrels.

## 10. Kick-Off Selection

A removable screw mechanism selects kick-off (screw fitted) or no kick-off (screw removed).

## 11. Faceplate

Stainless steel faceplate supplied in square end (standard) and optional round end.

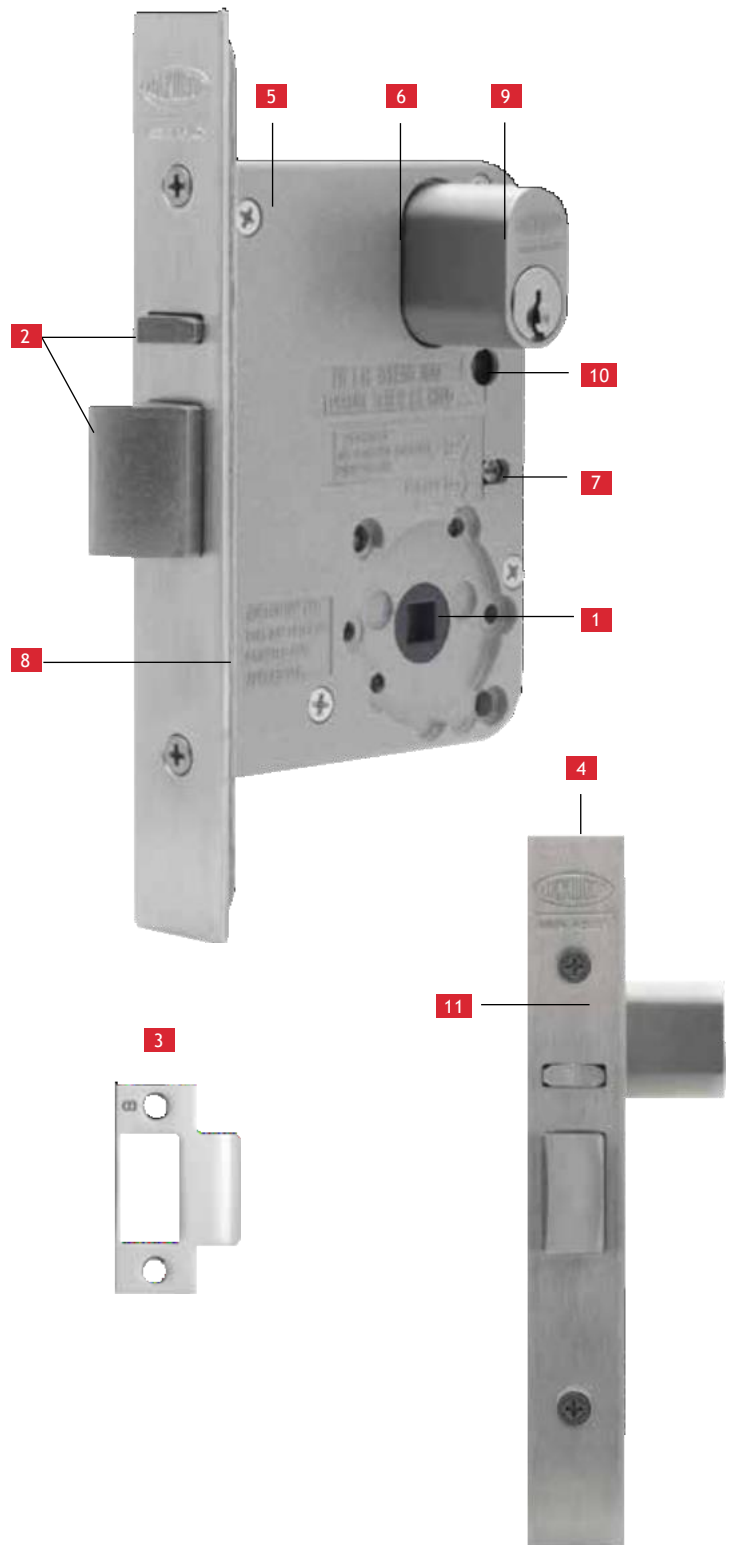

# Synergy 3570 Nightlatches



## Description

Various latching functions operated by a key outside and by a turnknob or key inside. The nightlatch locks automatically when the door is closed.

For all nightlatch functions specify the primary lock. This lock can then be easily adapted to suit function required.

## Product Details

<b>Furniture</b>	Compatible with most Lockwood cylinder escutcheons, turnknobs and plate furniture. Refer to <a href="http://lockweb.com.au">lockweb.com.au</a> for further details.
<b>Latch</b>	Deadlatch only.
<b>Standard Finishes</b>	Satin Chrome Brushed (SC) Chrome Plate (CP) Polished Brass (PB) Other finishes on application.

# Synergy 3570 Nightlatches

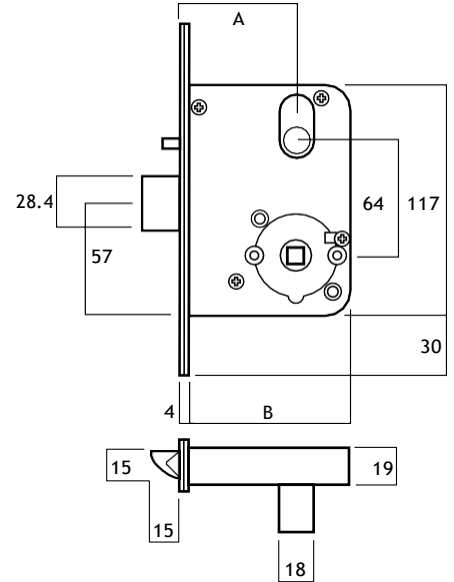
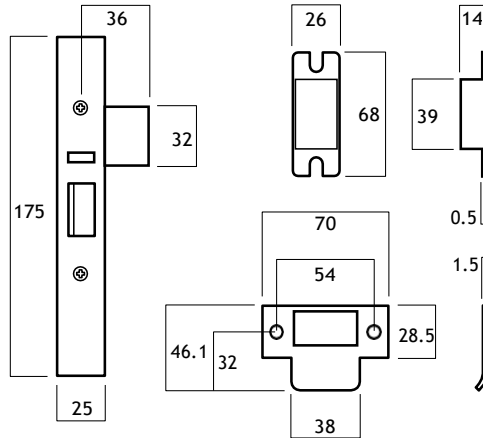

## Synergy 3570 Nightlatches

Part Number	3570	4570	5570
Dimension A	60	89	127
Dimension B	84	113	151

Note: 3572SC Primary Lock can be used to achieve 3570 functions.

# Synergy 3570 Nightlatches

## Nightlatch

Part Number	Description
3570XTR	Right hand
3570XTL	Left hand

### Description

Cylinder and Turnknob. Reversible.

**Outside:** Opened by key.

**Inside:** Opened by turnknob.

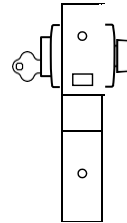

Nightlatch

## Communicating Door Latch

Part Number	Description
3570XX	Non-handed.

### Description

Double Cylinder. Reversible.

**Outside:** Opened by key.

**Inside:** Opened by key.

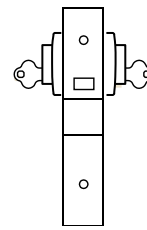

Communicating Door Latch

## Exit Door Latch

Part Number	Description
3570-TR	Right hand
3570-TL	Left hand

### Description

Turnknob inside. Reversible.

**Inside:** Opened by turnknob.

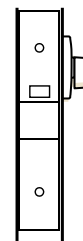

Exit Door Latch

## Cylinder Latch

Part Number	Description
3570X-R	Right hand
3570X-L	Left hand

### Description

Single Cylinder. Reversible.

Lockset may be installed with cylinder either inside or outside.

**Outside/Inside:** Opened by key.

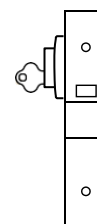

Cylinder Latch

**Note:** Part numbers shown above are for 60mm backset lock, if 89mm is required substitute 3 for 4 i.e. 4570XX, or if 127mm lock is required, substitute 3 for 5 i.e. 5570XX

# Synergy 3571 Deadbolts



## Description

Various deadlocking functions operated generally by a key outside and by a turnknob or key inside. Locked by key or turnknob when the door is closed.

For all deadlock functions specify primary lock (3571SC). This lock can then be easily adapted to suit function required.

## Product Details

<b>Backset</b>	60mm standard backset 89 and 12mm extended backsets available on application.
<b>Bolt</b>	19mm stainless steel bolt.
<b>Furniture</b>	Compatible with most Lockwood cylinder escutcheons, turnknobs and plate furniture. Refer to <a href="http://lockweb.com.au">lockweb.com.au</a> for further details.
<b>Standard Finishes</b>	Satin Chrome Brushed (SC) Chrome Plate (CP) Polished Brass (PB) Other finishes on application.

# Synergy 3571 Deadbolts

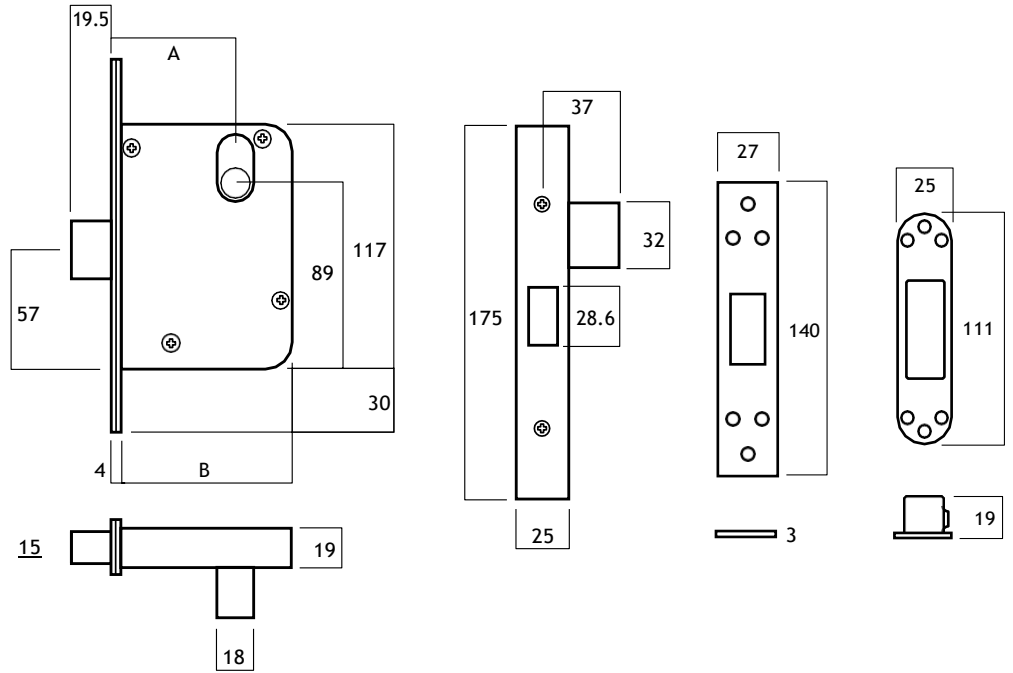

## Synergy 3571 Deadbolts

Part Number	3571	4571	5571
Dimension A	60	89	127
Dimension B	84	113	151

# Synergy 3571 Deadbolts

## Cylinder and Turn Deadbolt

Part Number 3571WT

### Description

Cylinder and Turnknob. Reversible.  
**Outside:** Locked or unlocked by key.  
**Inside:** Locked or unlocked by turnknob.

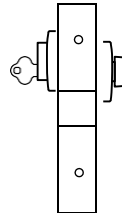

Cylinder and Turn Deadbolt

## Double Cylinder Deadbolt

Part Number 3571YY

### Description

Double Cylinder. Reversible.  
**Outside:** Locked or unlocked by key.  
**Inside:** Locked or unlocked by key.

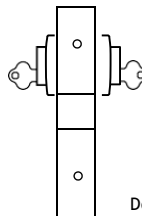

Double Cylinder Deadbolt

## Exit Door Deadbolt

Part Number 3571-T

### Description

Turnknob Inside. Reversible.  
**Inside:** Locked or unlocked by turnknob.

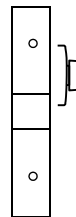

Exit Door Deadbolt

## Single Cylinder Deadbolt

Part Number 3571Y

### Description

Single Cylinder. Reversible.  
Lockset may be installed with cylinder either inside or outside.  
**Outside/Inside:** Locked or unlocked by key.

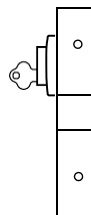

Single Cylinder Deadbolt

# Synergy 3571 Deadbolts

## Escape Deadbolt

Part Number	Description
3571DEL	Left Hand
3571DER	Right Hand

### Description

Cylinder and Escape Lever.

**Outside:** Locked or unlocked by key.

**Inside:** Unlocked only by escape turn. Inside turn will not lock door.

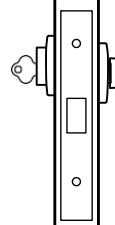

Escape Deadbolt

**Note:** Specially machined lock case cannot be made up from 3571 primary lock and cannot be reversed.

## Through Fix Privacy Deadbolt

Part Number	3571PT
-------------	--------

### Description

Emergency Turnknob Escutcheon. Turnknob. Reversible.

**Outside:** Operated by coin or screwdriver in emergency situation by operating the slotted emergency turn button.

**Inside:** Locked or unlocked by turn knob.

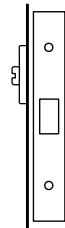

Through Fix Privacy Deadbolt

**Note:** Requires specially machined lockcase. Furniture must be ordered separately.

# Synergy 3572 Vestibule Lock



## Description

These locks have various latching functions which can be operated by key or handle outside and by turnknob, key or handle inside. For ease of selection specify primary lock. This lock can then be easily adapted to suit function required. These locks have various latching functions which can be operated by key or by a handle inside.

## Product Details

<b>Backset</b>	Available in 60, 89 and 127mm backsets.
<b>Furniture</b>	Compatible with most Lockwood rose and plate furniture including Brass Door Furniture, Daintree, Aquileart, Artefact Series II and Ovation Series. Refer to <a href="http://lockweb.com.au">lockweb.com.au</a> for further details.
<b>Latch</b>	Deadlatch only.
<b>Standard Finishes</b>	Satin Chrome Brushed (SC) Chrome Plate (CP) Polished Brass (PB) Other finishes on application.

# Synergy 3572 Vestibule Lock

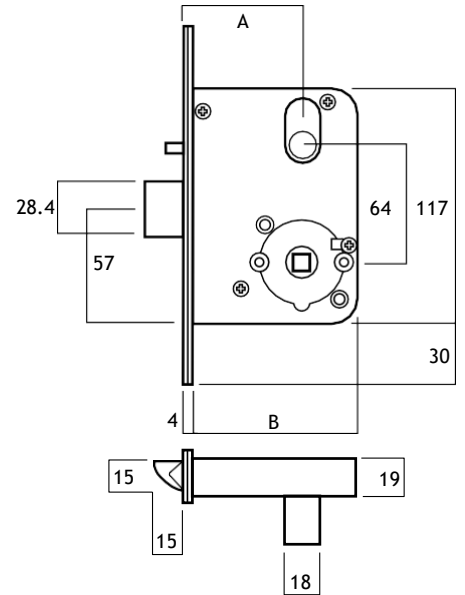
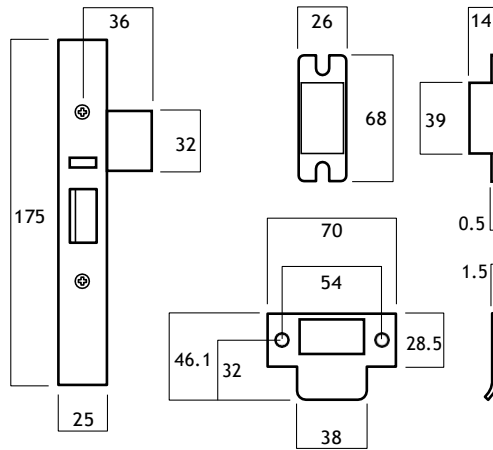

## Synergy 3572 Vestibule Lock

Part Number	3572	4572	5572
Dimension A	60	89	127
Dimension B	84	113	151

# Synergy 3572 Vestibule Lock

## Storeroom Locking Latch

Part Number	Description
3572X-R	Right hand
3572X-L	Left hand

### Description

Cylinder Outside. Reversible.

**Outside:** Opened by key. Handle is always rigid.

**Inside:** Opened by handle at all times.

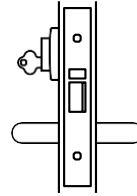

Storeroom Locking Latch

## Single Action Escape Latch

Part Number	Description
3572X-R	Right hand
3572X-L	Left hand

### Description

Cylinder Outside. Reversible.

**Outside:** Opened by key.

**Inside:** Opened by handle at all times.

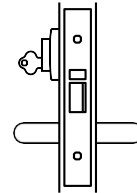

Single Action Escape Latch

## Classroom and Office Locking Latch

Part Number	Description
3572Z-R	Right hand
3572Z-L	Left hand

### Description

Cylinder Outside. Reversible.

**Outside:** Opened by handle except when handle is made inoperative by key from outside. Key locks or unlocks outside handle.

**Inside:** Opened by handle at all times.

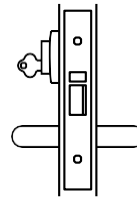

Classroom and Office Locking Latch

# Synergy 3572 Vestibule Lock

## Anti-lockout Privacy Escape Latch

Part Number	Description
3572EAR	Right hand
3572EAL	Left hand

### Description

Cylinder and Escape Lever.

**Outside:** Opened by handle except when handle is made inoperative by turnknob from inside. Handle may be unlocked from outside by coin or screwdriver by operating the slotted emergency button.

**Inside:** Opened by handle at all times. Turnknob locks or unlocks outside handle.

**Anti-lockout:** Closing the door or operation of inside handle will 'kick-off' the locking feature, allowing the outside handle to become operative.

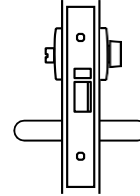

Anti-lockout Privacy Escape Latch

## Anti-lockout Entry Door Lock

Part Number	Description
3572XAR	Right hand
3572XAL	Left hand

### Description

Cylinder and Turnknob. Handed.

**Outside:** Opened by key at all times. Opened by handle except when handle is made inoperative by key from outside or turnknob from inside.

**Inside:** Opened by handle at all times. Turnknob locks or unlocks outside handle.

**Anti-lockout:** Latching the bolt by key, closing the door or operation of inside handle will 'kick-off' the locking feature, allowing the outside handle to become operative.

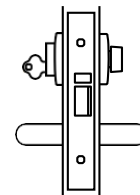

Anti-lockout Entry Door Lock

Notes: a) Latchbolt can be retracted by key if handle has been rendered inoperative.

b) Specially machined lock case, cannot be made up from 3572 primary lock.

# Synergy 3572 Vestibule Lock

## Classroom and Office Locking/Latching Latch

Part Number	Description
3572M-R	Right hand
3572M-L	Left hand

### Description

Locking/Latching Cylinder Outside. Handed.

**Outside:** Opened by key at all times. Opened by handle except when handle is made inoperative by key from outside. Key locks or unlocks outside handle.

**Inside:** Open by handle at all times.

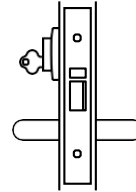

Classroom and Office Locking/  
Latching Latch

Note: Lock contains special adaptor to enable latch bolt to be retracted by key if handle has been rendered inoperative.

## Anti-lockout Vestibule Set

Part Number	Description
3572WAR	Right hand
3572WAL	Left hand

### Description

Cylinder and Turnknob. Handed.

**Outside:** Opened by handle except when handle is made inoperative by key from outside. Key locks or unlocks outside handle.

**Inside:** Open by handle at all times. Turnknob locks or unlocks outside handle

**Anti-lockout:** Closing the door or operation of inside handle will 'kick-off' the locking feature, allowing the outside handle to become operative.

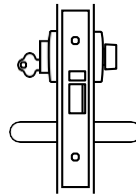

Anti-lockout Vestibule Set

# Synergy 3572 Vestibule Lock

## Vestibule Set

Part Number	Description
3572XTR	Right hand
3572XTL	Left hand

### Description

Cylinder and Turnknob. Reversible.

**Outside:** Opened by key at all times. Opened by handle except when handle is made inoperative by turnknob inside.

**Inside:** Opened by handle at all times. Turn knob locks or unlocks outside handle.

**Note:** Part numbers shown above are for 60mm backset lock, if 89mm is required substitute 3 for 4 i.e. 45722-R, or if 127mm lock is required, substitute 3 for 5 i.e. 5572Z-R

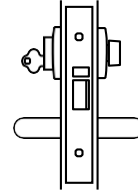

Vestibule Set

## Exit Door Latch

Part Number	Description
3572R	Right hand
3572L	Left hand

### Description

Exit Function Only. Reversible.

**Outside:** Handle is always rigid.

**Inside:** Opened by handle at all times.

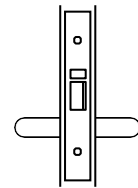

Exit Door Lock

# Synergy 3572 Vestibule Lock

## Exterior and Exit Door Lock

Part Number	Description
3572XZR	Right hand
3572XZL	Left hand

### Description

Exit Function Only. Reversible.

**Outside:** Opened by key at all times. Opened by handle except when handle is made inoperative by key from inside.

**Inside:** Opened by handle at all times. Key locks or unlocks outside handle.

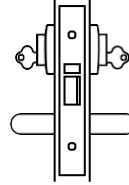

Double Cylinder Escape Lock

## Exterior and Exit Door Lock

Part Number	Description
3572-ZR	Right hand
3572-ZL	Left hand

### Description

Cylinder Inside. Reversible.

**Outside:** Opened by handle except when handle is made inoperative by key from inside.

**Inside:** Opened by handle at all times. Key locks or unlocks outside handle.

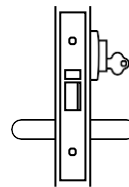

Single Cylinder Exit Door Lock

# Synergy 3572 Vestibule Lock

## Exterior and Exit Door Lock

Part Number	Description
3572-TR	Right hand
3572-TL	Left hand

### Description

Cylinder and Escape Lever.

**Outside:** Opened by handle except when handle is made inoperative by turnknob from inside.

**Inside:** Opened by handle at all times. Turnknob locks or unlocks outside handle.

**Note:** Part numbers shown above are for 60mm backset lock, if 89mm is required substitute 3 for 4 i.e. 4572Z-R, or if 127mm lock is required, substitute 3 for 5 i.e. 5572Z-R

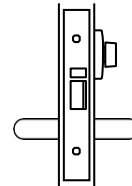

Exit Door Lock

# Synergy 3573 Sliding Door Deadbolt



## Description

Various deadlocking functions operated generally by key outside and by turnknob or key inside. Locked by key or turnknob when door is closed.

For sliding door deadlock functions specify primary lock (3573SC). This lock can then be easily adapted to suit function required.

## Product Details

<b>Backset</b>	60mm standard backset 89 and 127mm extended backsets available on application.
<b>Bolt</b>	Deadlock.
<b>Furniture</b>	Compatible with most Lockwood cylinder escutcheons, turnknobs and plate furniture. Refer to <a href="http://lockweb.com.au">lockweb.com.au</a> for further details.
<b>Standard Finishes</b>	Satin Chrome Brushed (SC) Chrome Plate (CP) Polished Brass (PB) Other finishes on application.

# Synergy 3573 Sliding Door Deadbolt

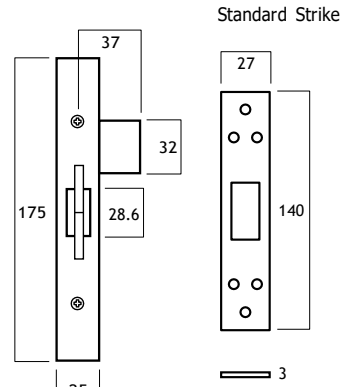
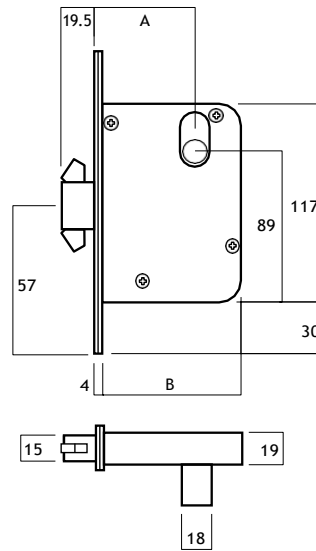
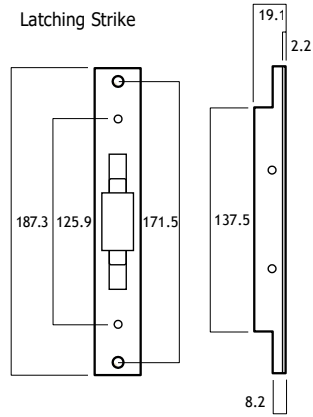

## Synergy 3573 Sliding Door Deadbolt

Part Number	3573	4573	5573
Dimension A	60	89	127
Dimension B	84	113	151

For installations requiring a self latching strike, order 3573SCLS for special lock and strike kit.

# Synergy 3573 Sliding Door Deadbolt

## Sliding Door Deadlock

Part Number 3573WT

### Description

Exit Function Only. Reversible.

**Outside:** Locked or unlocked by key.

**Inside:** Locked or unlocked by turnknob.

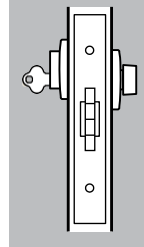

Sliding Door Cylinder and Turn Deadbolt

## Sliding Glass Door Deadlock

Part Number 3573YY

### Description

Double Cylinder. Reversible.

**Outside:** Locked or unlocked by key.

**Inside:** Locked or unlocked by key.

**Note:** Recommended for glass doors.

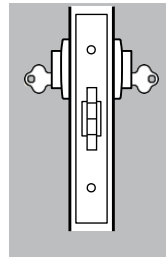

Sliding Double Cylinder Deadbolt

## Exit Sliding Door Deadbolt

Part Number 3573-T

### Description

Turnknob Inside. Reversible.

**Inside:** Locked or unlocked by turnknob.

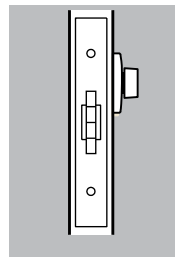

Exit Sliding Door Deadbolt

## Lockup Shop Sliding Door Deadlock

Part Number 3573Y -

### Description

Single Cylinder. Reversible.

**Outside:** Locked or unlocked by key.

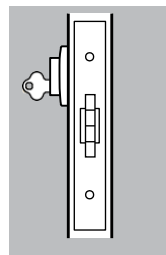

Single Cylinder Sliding Door Deadbolt

# Synergy 3573 Sliding Door Deadbolt

## Sliding Door Escape Deadlock

Part Number	Description
3573DEL	Left hand
3573DER	Right hand

### Description

Cylinder and Escape Lever.

**Outside:** Locked or unlocked by key.

**Inside:** Unlocked only by escape turn. Inside turn will not lock door..

## Sliding Door Through Fix Privacy Latch

Part Number	3573PT
-------------	--------

### Description

Emergency Turnknob Escutcheon. Turnknob. Reversible.

**Outside:** Locked or unlocked by coin or screwdriver.

**Inside:** Locked or unlocked by turnknob.

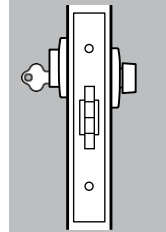

Sliding Door Escape Deadbolt

**Note:** Specially machined lock case. Cannot be made up from 3573 primary lock and cannot be reversed.

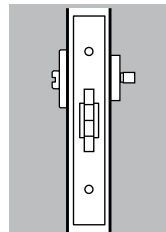

Sliding Door Through Fix Privacy Bolt

**Note:** Requires specially machined lock case. Furniture must be ordered separately.

# Synergy 3574 Combination Latches



## Description

Various latching functions operated generally by outside or inside handles, except when locked by key outside or by key or turnknob inside.

For ease of selection specify primary lock (3572SC). This lock can then be easily adapted to function required.

**Note:** Passage set available with plain latch only (3574SC).

## Product Details

<b>Backset</b>	Available in 60, 89 and 127mm backsets.
<b>Furniture</b>	Compatible with most Lockwood rose and plate furniture including Brass Door Furniture, Daintree, Aquileart, Artefact Series II and Ovation Series. Refer to <a href="http://lockweb.com.au">lockweb.com.au</a> for further details.
<b>Latch</b>	Deadlatch for locking functions. Plain latch for passage function.
<b>Standard Finishes</b>	Satin Chrome Brushed (SC) Chrome Plate (CP) Polished Brass (PB) Other finishes on application.

# Synergy 3574 Combination Latches

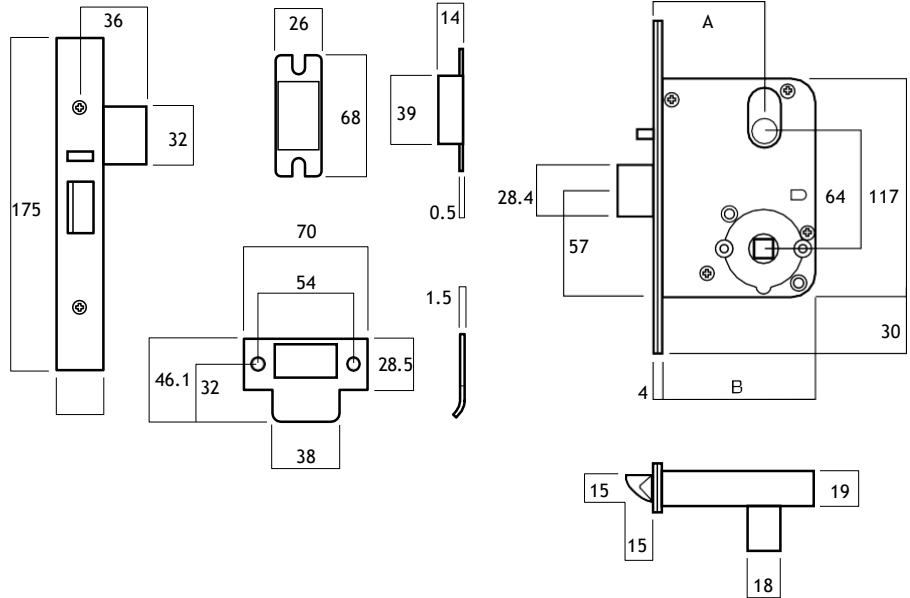

## Synergy 3574 Combination Latches

Part Number	3572	4572	5572
Dimension A	60	89	127
Dimension B	84	113	151

# Synergy 3574 Combination Latches

## 3574 Combination Latches

### Office Locking Latch

Part Number	Description
3574WTR	Right hand
3574WTL	Left hand

### Description

Cylinder and turnknob. Reversible.

**Outside:** Opened by handle except when handle is made inoperative by key from outside or by turnknob from inside. Key locks or unlocks both handles.

**Inside:** Opened by handle except when handle is made inoperative by key from outside or turnknob from inside. Turnknob locks or unlocks both handles.

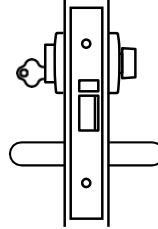

### Glass Door Locking Latch

Part Number	3574ZZ
-------------	--------

### Description

Double Cylinder. Non-handed.

**Outside:** Opened by handle except when handle is made inoperative by key from either side. Key from either side locks or unlocks both handles.

**Inside:** Opened by handle except when handle is made inoperative by key from either side. Key from either side locks or unlocks both handles.

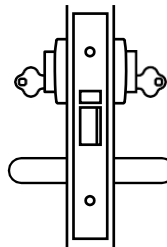

# Synergy 3574 Combination Latches

## Glass Door Locking Latch

Part Number	Description
3574Z-R	Right hand
3574Z-L	Left hand

### Description

Cylinder and outside. Reversible.

**Outside:** Opened by handle except when handle is made inoperative by key from outside. Key locks or unlocks both handles.

**Inside:** Opened by handle except when handle is made inoperative by key from outside.

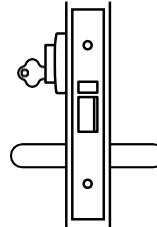

## Passage Latch

Part Number	3574
-------------	------

### Description

No locking function. Non-handed. Plainlatch only.

**Outside:** Opened by handle.

**Inside:** Opened by handle.

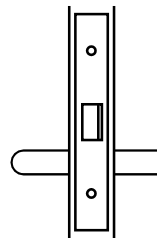

# Synergy 3574 Combination Latches

## Privacy Latch

Part Number	Description
3574ETR	Right hand
3574ETL	Left hand

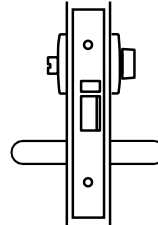

### Description

Emergency button and turnknob. Reversible..

**Outside:** Opened by handle except when handle is made inoperative by emergency turnknob from outside or turnknob from inside. Emergency turnknob locks or unlocks both handles.

**Inside:** Opened by handle except when handle is made inoperative by emergency turnknob from outside or turnknob from inside. Emergency turnknob locks or unlocks both handles.

## Glass Door Locking Latch

Part Number	Description
3574XZR	Right hand
3574XZL	Left hand

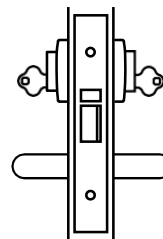

### Description

Cylinder outside. Reversible.

**Outside:** Opened by key at all times.

Opened by handle except when handle is made inoperative by key from inside. Key retracts latchbolt.

**Inside:** Opened by handle except when handle is made inoperative by key from inside. Key locks or unlocks both handles.

**Note:** Part numbers shown above are for 60mm backset lock, if 89mm is required substitute 3 for 4 i.e. 4572Z-R, or if 127mm lock is required, substitute 3 for 5 i.e. 5572Z-R

# Synergy 3577 Dual Entry Deadlatch



## Description

Designed to enable emergency services to enter specific areas by second cylinder without giving access to all locksets in the building and the ability to lockout keys with restricted access at certain times.

## Product Details

<b>Furniture</b>	Select from Lockwood 1800, 2800 or Artefact Series II ranges. Refer to <a href="http://lockweb.com.au">lockweb.com.au</a> for further details.
<b>Standard Finishes</b>	Satin Chrome Brushed (SC) Chrome Plate (CP) Polished Brass (PB) Other finishes on application.

# Synergy 3577 Dual Entry Deadlatch

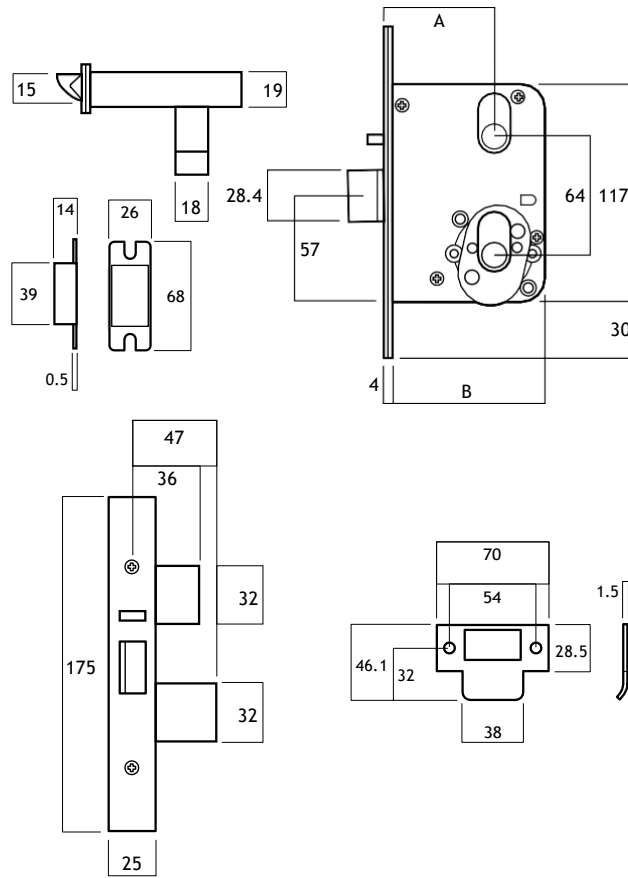

## Synergy 3577Dual Entry Deadlatch

Part Number	3577	4577	5577
Dimension A	60	89	127
Dimension B	84	113	151

**Note:** Can be made using 3572SC and SP3577-5619 Lower Cylinder Accessory pack. Cylinders must be ordered separately.

## Dual Entry Deadlatch

Part Number	Description
3577X-R	Right hand
3577X-L	Left hand

### Description

Two Cylinders Outside.

**Outside:** Opened by key, cylinders are keyed to differ.

**Inside:** Opened by handle at all times.

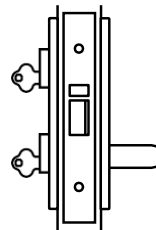

# Synergy 3577 Dual Entry Deadlatch

## Dual Entry/Key Lockout Deadlatch

Part Number	Description
3577Z-R	Right hand
3577Z-L	Left hand

### Description

Two Cylinders Outside.

**Outside:** Opened by bottom key. Top key locks and unlocks bottom key.

**Inside:** Opened by handle at all times.

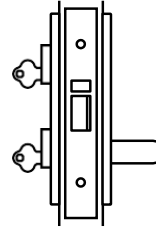

## Dual Entry/Key Lockout Latching Latch

Part Number	Description
3577M-R	Right hand
3577M-L	Left hand

### Description

Two Cylinders Outside.

**Outside:** Opened by bottom key when made operative by top key.

Top key locks or unlocks bottom key and retracts latch.

**Inside:** Opened by handle at all times.

**Note:** Part numbers shown above are for 60mm backset lock, if 89mm is required substitute 3 for 4 i.e. 4577XR, or if 127mm lock is required, substitute 3 for 5 i.e. 5577XR

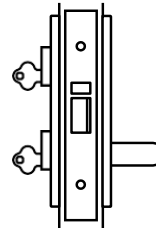

## Key Entry Privacy Lock

Part Number	Description
3577-TR	Right hand
3577-TL	Left hand

### Description

Cylinder Outside.

**Outside:** Opened by bottom key except when locked out by turnknob from inside.

**Inside:** Opened by handle at all times. Turnknob locks out outside key.

**Anti-lockout:** Closing the door or operation of inside handle will "kick-off" the locking feature, allowing the outside key to become operative.

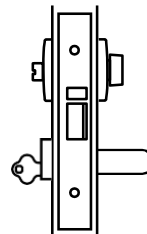

# Synergy 3578 Holdback Deadlatches



## Description

A deadlatching lockset for applications where latch holdback is required such as high use doors and toilet doors.

## Product Details

<b>Furniture</b>	Compatible with most Lockwood rose and plate furniture including Brass Door Furniture, Daintree, Aquileart, Artefact Series II and Ovation series. Refer to <a href="http://lockweb.com.au">lockweb.com.au</a> for further details.
<b>Latch</b>	Deadlatch
<b>Standard Finishes</b>	Satin Chrome Brushed (SC) Chrome Plate (CP) Polished Brass (PB)

## Standards and Compliance



Holdback Deadlatches are non-fire rated.

# Synergy 3578 Holdback Deadlatches

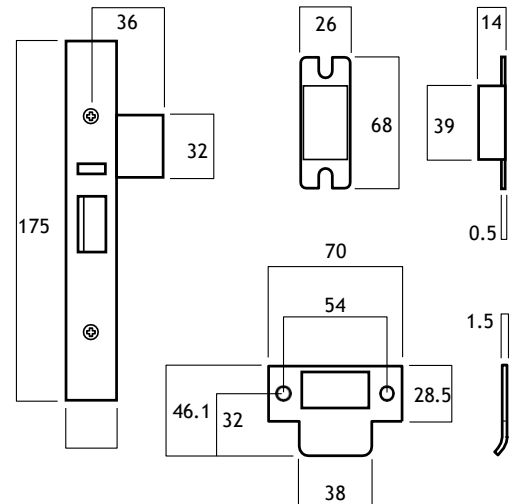
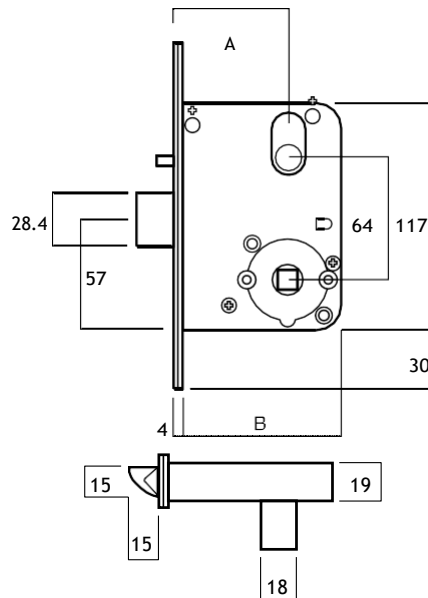

## Synergy 3578 Holdback Deadlatches

Part Number	3578	4578	5578
Dimension A	60	89	127
Dimension B	84	113	151

# Synergy 3578 Holdback Deadlatches

## Classroom and Office Locking/Latching Latch with Holdback

Part Number	Description
3578Z-R	Right hand
3578Z-L	Left hand

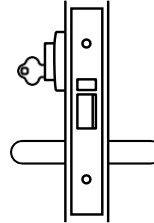

### Description

Cylinder Outside. Reversible.

**Outside:** Opened by handle except when handle is made inoperative by key from outside. Key locks or unlocks outside handle.

**Inside:** Open by handle at all times. Holdback: Latchbolt held back when latch depressed and key rotated 360°.

## Holdback Vestibule Set

Part Number	Description
3578WTR	Right hand
3578WTL	Left hand

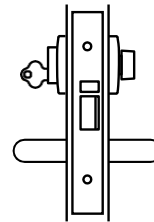

### Description

Cylinder and Turnknob. Handed.

**Outside:** Opened by handle except when handle is made inoperative by key from outside or turnknob from inside. Key locks or unlocks outside handle.

**Inside:** Opened by handle at all times. Turnknob locks or unlocks outside handle.

**Holdback:** Latchbolt held back when latch depressed and key or turnknob rotated 90°.

**Note:** Part numbers shown above are for 60mm backset lock, if 89mm is required substitute 3 for 4 i.e. 4578Z-R, or if 127mm lock is required, substitute 3 for 5 i.e. 5578Z-R

# Synergy 3579 Series Mortice Locks and Deadbolts

SCEC Endorsed (Secure Area)



## Description

For use in high security government, institutional and commercial projects. The 3579 Series Mortice Lock has been successfully SCEC endorsed for secure area applications.

## Features and Specifications

- All handing type features of the lock including hub selection, anti-lockout screw and reversible latch are accessible without removing the plates.
- 570 oval type cylinders and retaining pin can be used (cylinder must also be appropriately SCEC endorsed)
- 2 x 1.2mm stainless steel plates fixed through the lock provide increased strength to the cylinder and latch areas of the lock
- Available with all 3570, 3571, 3572 and 3574 functions

To achieve secure area rating, the 3579 Mortice Lock must also:

- Be fitted with a SCEC endorsed 570 oval cylinder which also secure area rated, e.g ABLOY PROTEC. Visit [assaabloy.com.au](http://assaabloy.com.au)
- Be fitted with full plate furniture including Lockwood 1800 Series and Artefact Series II

## Product Details

<b>Furniture</b>	Select from the Lockwood 1800, 2800 or Artefact Series II plate furniture ranges to maintain compliance with SCEC Secure Area ratings. Available in Nightlatch Deadbolt, Vestibule Set and Combination lock configurations - refer to relevant previous pages within the catalogue for further function detail.
<b>Keying</b>	Can be keyed alike, master keyed, grand master keyed, maison keyed or construction keyed in SCEC Secure Area Endorsed Keying System, ABLOY PROTEC (cylinder not included). For information on ABLOY PROTEC visit <a href="http://assaabloy.com.au">assaabloy.com.au</a>
<b>Standard Finishes</b>	Satin Chrome Brushed (SC) Chrome Plate (CP) Polished Brass (PB)



## Standards and Compliance



The Lockwood 3579 Series Cylinder Mortice Lock has been successfully fire tested up to 4 hours on fire door assemblies in accordance with Australian Standard AS1905.1 - 2005, Part 1: Fire Resistant Doorsets.

# Synergy 3579 Series Mortice Locks and Deadbolts

SCEC Endorsed (Secure Area)



## Synergy 3579 Series Mortice Locks and Deadbolts SCEC Endorsed (Secure Area)

<b>Deadbolt</b>	35791
<b>Deadlatch</b>	35792

# Synergy Series - Accessories

## Short/Extended Lipped Strikes

### Standard Finishes

Chrome Plate	CP
Satin Stainless Steel	SS
Polished Brass	PB

To order, add finish code to part number.

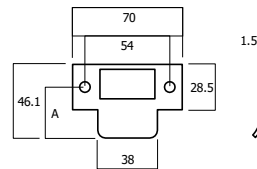

Dimension "A"

25.4mm	32mm	43.5mm	47.5mm
--------	------	--------	--------

3772-STK25	3772-STK32	3772-STK43	3772-STK47
------------	------------	------------	------------

## Fire Rated (4hr) Rebate Kits

### Finishes

Stainless Steel	SS
Chrome Plate	CP
Polished Brass	PB

### Description

Rebate kits to suit standard 13mm rebate.

To order, add finish code to part number.

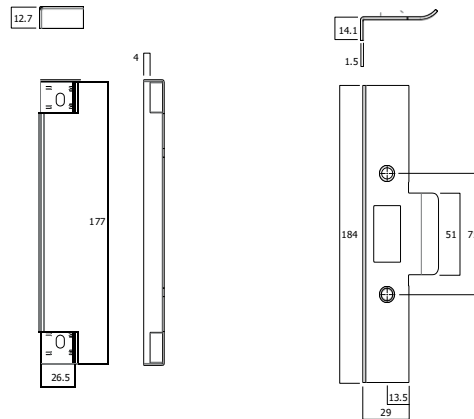

Lip Length "A" Rebate Kit Part Number

32mm	3772-RK32
------	-----------

46mm	3772-RK46
------	-----------

## Deadlock Rebate Kits (3571/3573)

### Rebate Kit Part Number 3571 - 2902

### Standard Finishes

Chrome Plate	CP
Satin Chrome Brushed	SC
Polished Brass	PB

To order, add finish code to part number.

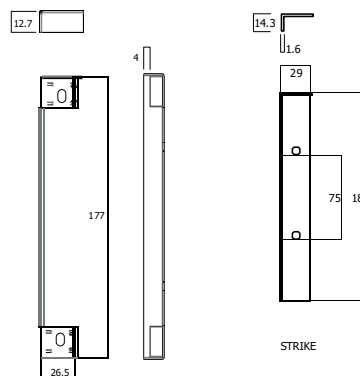

# Synergy Series - Accessories

## Holdback Cylinder

Part Number	Right Hand	Part Number	Left Hand
3570-2402CP	Chrome Plate	3570-2452CP	Chrome Plate
3570-2402SC	Satin Chrome Brushed	3570-2452SC	Satin Chrome Brushed
3570-2402PB	Polished Brass	3570-2452PB	Polished Brass

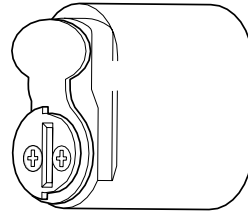

### Description

- For use with 3570 Series locks only
- Special latching cylinders with levers that enable the latchbolt to be held in retracted position
- To apply Holdback: Insert key into cylinder and retract bolt with one full turn of key, hold bolt depressed with finger and withdraw key
- To release Holdback: Insert key into cylinder, rotate key one full turn and withdraw key

## Mortice Lock Sprindles

Part Number	Pack Size	Length "A"	Door Thickness	
			Min	Max
SP3570-5018	10	33mm	32	50
SP3570-5228	10	45mm	50	75
SP3570-5238	0	58mm	75	100
SP3570-5258	10	108mm	100	200
SP3570-5328	10	125mm	200	240

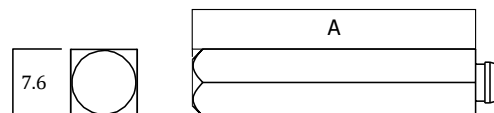

# Synergy Series - Accessories

## Single Cylinder Assemblies

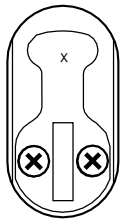

"X" CAM  
570-2

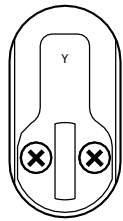

"Y" CAM  
571-2

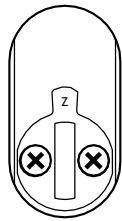

"Z" CAM  
572-2

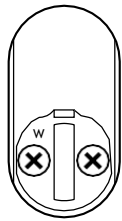

"W" CAM  
575-2

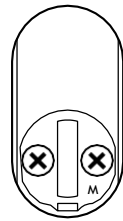

"M" CAM  
575-52

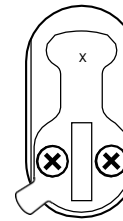

"XAL" CAM  
3572-6118  
(cam only)  
Included in "XA"  
lock assembly

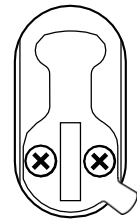

"XAR" CAM  
3572-6218  
(cam only)  
Included in "XA"  
lock assembly

## Double Cylinder Assemblies

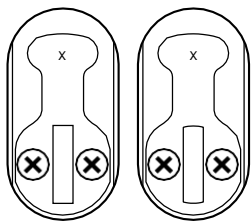

"X" CAMS  
570-701

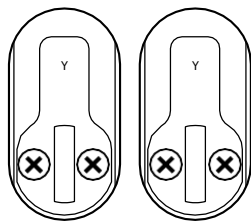

"Y" CAMS  
571-701

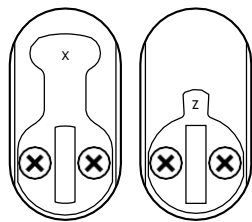

"X" CAM AND "Z" CAM  
574-701

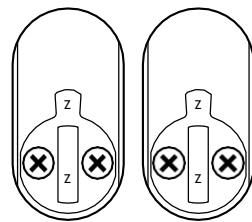

"Z" CAMS  
575-701

## Adaptors

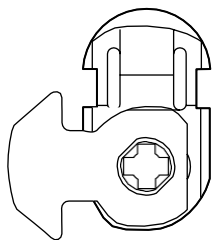

SP3570-5050  
Nightlatch Turn Adaptor

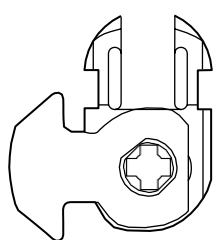

SP3570-6050  
Nightlatch Turn Adaptor  
(for Case Fix Turns)

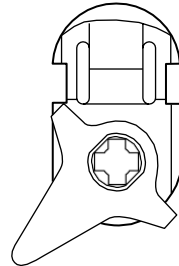

SP3571-5050  
Deadlock Turn Adaptor

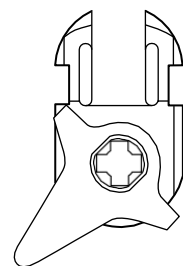

SP3571-6050  
Deadlock Turn Adaptor  
(for Case Fix Turns)

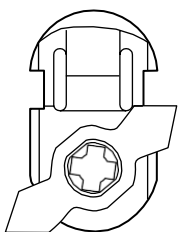

SP3572-5250  
Standard Turn Adaptor

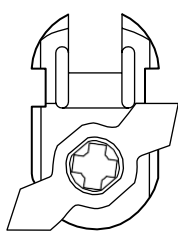

SP3572-6250  
Standard Turn Adaptor  
(for Case Fix Turns)

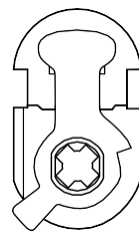

SP3572-5350  
(RH)  
Anti-Vandal Turn Adaptor

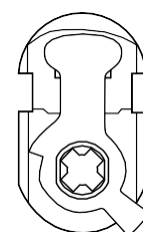

SP3572-5450  
(LH)  
Anti-vandal Turn Adaptor

# Synergy Series Cam and Adaptors Function Chart

## Synergy Series Cam and Adaptors Function Chart

Synergy Series	Function Description	Primary Lock	Cylinder(s)	Turn Adaptor	Outside Cylinder Cam	Inside Cylinder Cam
3570SC	<i>Nightlatch Primary Lock</i>	3570SC	-	-		
3570-T#SC	Nightlatch - turn only	3570SC	-	SP3570-5050		
3570X-#SC	Nightlatch - single cyl	3570SC	570-2SC	-	X	
3570XT#SC	Nightlatch - cyl & turn	3570SC	570-2SC	SP3570-5050	X	
3570XX#SC	Nightlatch - double cyl	3570SC	570-701SC	-	X	X
3571SC	<i>Deadlock Primary Lock</i>	3571SC	-	-		
3571DE#SC	<i>Escape Deadlock</i>	3571DE#SCNCYL	571-2SC	(SP3571-6050)*	Y	
3571-T#SC	Exit Door Deadlock	3571SC	-	SP3571-5050		
3571PT	<i>Privacy Deadlock (Through Fix)</i>	3571PTSC	-	(SP3571-5050)*		
3571WT#SC	Cylinder and Turn Deadlock	3571SC	571-2SC	SP3571-5050	Y	
3571Y-#SC	Single Cylinder Deadlock	3571SC	571-2SC	-	Y	
3571YY#SC	Double Cylinder Deadlock	3571SC	571-701SC	-	Y	Y
3572SC	<i>Multi-function Primary Lock</i>	3572SC	-	-		
3572#SC	Exit Door Latch	3572SC	-	-		
3572EA#SC	Escape Privacy Latch - Antilockout	3572SC	-	SP3572-5250		
3572M-#SC	Anti-Vandal Latch	3572SC	575-52SC	SP3572-5350 (RH), SP3572-5450 (LH)	M	
3572-T#SC	Exit Door Lock - turn only	3572SC	-	SP3572-5250		
3572WA#SC	Escape Office Lock - Antilockout	3572SC	575-2SC	SP3572-5250	W	
3572WT#SC	Escape Office Lock	3572SC	575-2SC	SP3572-5250	W	
3572X-#SC	Storeroom Lock	3572SC	570-2SC	-	X	
3572XA#SC	<i>Entry Door Lock - Anti-vandal</i>	3572XA#SCNCYL	570-302LHSC, 570-302RHSC	(SP3572-5250)*	XAL/XAR	
3572XT#SC	Entry Door Lock	3572SC	570-2SC	SP3572-5250	X	
3572XZ#SC	Double Cylinder Escape Lock	3572SC	574-701SC	-	X	Z
3572-Z#SC	Single Cylinder Exit Door Lock	3572SC	572-2SC	-		Z
3572Z-#SC	Classroom Lock	3572SC	572-2SC	-	Z	
3573SC	<i>Sliding Door Deadlock Primary Lock</i>	3573SC	-	-		
3573DE#SC	<i>Sliding Door Escape Deadlock</i>	3573DE#SCNCYL	571-2SC	(SP3571-6050)*	Y	
3573PTSC	<i>Sliding Door Privacy Lock (Through Fix)</i>	3573PTSC	-	(SP3571-5050)*		
3573-TSC	Sliding Exit Door Deadlock	3573SC	-	SP3571-5050		
3573WTSC	Sliding Door Cylinder and Turn Deadlock	3573SC	575-2SC	SP3571-5050	W	
3573Y-#SC	Single Cylinder Sliding Door Deadlock	3573SC	571-2SC	-	Y	
3573YY#SC	Double Cylinder Sliding Door Deadlock	3573SC	571-701SC	-	Y	Y
3574SC	<i>Passage Latch</i>	3574SC	-	-		
3574#SC	Passage Latch	3574SC	-	-		
3574ET#SC	Privacy Latch	3572SC	-	SP3572-5250		
3574WT#SC	Office Lock	3572SC	575-2SC	SP3572-5250	W	
3574XX#SC	Double Cylinder Override Lock	3572SC	570-701SC	-	X	X
3574XZ#SC	Glass Entry Door Lock	3572SC	574-701SC	-	X	Z
3574-Z#SC	Single Cylinder Glass Door Lock	3572SC	572-2SC	-		Z
3574Z-#SC	Single Cylinder Glass Entry Door Lock	3572SC	572-2SC	-	Z	
3574ZZ#SC	Double Cylinder Glass Door Lock	3572SC	572-701SC	-	Z	Z
3577SC	<i>Dual Entry Primary Lock</i>	3577SC~	-	-		
3577EA#SC	Key Entry Privacy Lock	3577SC~	577-2SC	SP3572-5250		
3577M#	Dual Entry Lock - Key Lockout	3577SC~	575-52SC and 577-2SC	SP3572-5350 (RH), SP3572-5450 (LH)	M	
3577X#	Dual Entry Lock	3577SC~	570-2SC and 577-2SC	-	X	
3578SC	<i>Holdback Primary Lock</i>	3578SC	-	-		
3578M-#SC	Anti-Vandal Latch - Holdback	3578SC	575-52SC	SP3572-5350 (RH), SP3572-5450 (LH)	M	
3578WT#SC	Escape Office Lock - Holdback	3578SC	575-2SC	SP3572-5250	W	
3578Z-#SC	Classroom Lock - Holdback	3578SC	572-2SC	-	Z	
3578XZ#SC	Double Cylinder Lock - Holdback	3578SC	574-701SC	-	X	Z

Items in Italics are Primary locks and can be purchased from ASSA ABLOY: # = Left ( L ) or Right ( R ) handing, \* = included with Primary Lock, ^ = cam only, included with Primary lock, ~ = can be ordered as 3572SC and SP3577-5619. Cylinders must be ordered separately.

# Synergy Series Cylinder Mortice Locks Functioning Matrix

## Functioning Matrix

Sample part number 3574WTRSCAF is made up of seven elements.  
The description of this part number is an office locking combination latch with cylinder and turn, right handing, satin chrome brushed, for aluminium fix. Choose your product by selecting an option from each element.

Backset	Platform	Function	Sub Function	Handing	Finish	Options	
3	57	4	WT	R	SC	AF	
Backset	Sub Function	Handing	Finish	Options			
60mm	3	Right Handed	Chrome Plate	Aluminium Fix	AF		
89mm	4	Left Handed	Satin Chrome Brushed	Latching strike (3573 only)	LS		
127mm	5		Polished Brass				
Platform							
Standard (Intruder Resistant)	57						
SCEC Secure Area*	579						
Functions							
Nightlatch	0						
Deadlock	1						
Vestibule Lock	2						
Sliding Door Lock	3						
Combination Lock	4						
Dual Entry Lock	7						
Hold Back Lock	8						

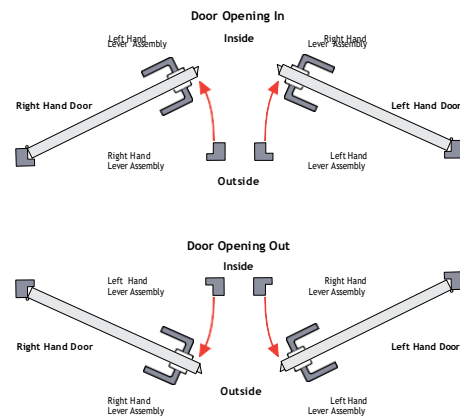

\*Secure Area only available in Nightlatch, Deadlock, Vestibule and Combination configuration. Must be used in conjunction with SCEC Secure Area rated cylinder (e.g. ABLOY PROTEC) and furniture (e.g. Lockwood 1800 Series).

## Code

- Backset:** Nominate backset as required, for example 3 = 60mm backset.
- Function:** Select function, for example 574 = Combination Lock
- Sub Function:** Determine sub function requirements for both exterior and interior.  
For example:  
Exterior – Locking function required – specify W (cylinder).  
Interior – turnknob function required – specify T (turnbutton adaptor).
- Handing:** If applicable refer to door handing chart to determine left or right hand, for example R.
- Finish:** Select appropriate finish, e.g. SC. Other finishes available on application.
- Options:** Where additional options are needed, specify as required, For example AF = Aluminium Fix.



# Synergy 3540 Series Mortice Locks

# 3540 Series Mortice Locks Overview

Lockwood's comprehensive range of Short Backset Cylinder Mortice Locksets offer a selection of lock functions ideally suited for narrow stile hinged and sliding doors.

Typical installations are glazed architectural and commercial stiles where conventional locksets with longer backsets are unsuitable.

## **3540 Series Cylinder Mortice Deadlocks with 22mm Bolt\***

Locksets incorporating a swinging deadbolt action suitable for hinged doors.

Features include unique 360° key rotation, positive deadlocking action and sintered stainless steel bolt.



## **3541 Series Cylinder Mortice Deadlocks with 28mm Hook Bolt**

Sliding and swing door deadlocks with a hooked deadbolt to engage and lock into a deadlatching or security strike when the bolt is in the thrown position.

Features include unique 360° key rotation, rear lock and strike support for extra strength and security, positive deadlocking action and sintered stainless steel bolt. 30mm backset version is also available.



## **3542 Series Cylinder Mortice Deadlocks with 35mm Hook Bolt\***

Swing door deadlocks combining the quality features of the 3540 series with a 35mm deadbolt for deeper frames and improved security.

\*Note: not suitable for sliding doors.



# 3540 Series Mortice Locks Overview

## Application

A wide range of security cylinder mortice locks suitable for heavy duty use in industrial and commercial buildings, institutions, clubs, schools, hospitals, hotels, retail and similar buildings.

## Features and Specifications

### Fixing

The 3540 series is available in fabricator, metal door and timber door fixing configurations.

### Case and Cover Plates

High purity zinc alloy material cases. Fabricator fixing configurations feature aluminium cover plates to match aluminium door stiles. Metal and timber door fixing configurations feature plated brass cover plates.

### Backset

- 23mm standard backset
- Extended backset 30mm is available for 28mm hook bolt configurations only.

### Bolts

Bolts are sintered stainless steel, in lengths of 22mm (3540), 28mm (3541) and 35mm (3542). The 28mm is hooked to suit sliding and swing applications and is chamfered for self latching.

### Lock and Strike Rear Support

To help prevent the lock and strike from being pushed into the frame in sliding door applications a rear support mechanism is incorporated.

### Springs

High-grade spring steel material, corrosion protected.

### Cylinder Retaining Pin

Hard-drawn spring steel wire, corrosion protected.

### Door Thickness

Suits hollow stile door sections with 28mm internal width and 50mm maximum external width.

Timber Doors: 32 to 50mm.

### Door Clearance

To ensure correct functioning of the hook bolt on swing doors when used in conjunction with the security and latching strikes, the clearance between the frame and the door should be 3mm. However, the hook bolt will engage with a 0mm –5.5mm gap on fabricator fixing and 0mm–7.5mm on metal/timber fixing.

### Security

All 3540 Series Cylinder Mortice Locks conform with Level S.7 (Physical Security) Australian Lock Standard (AS 4145.2-2008).

Conformance with Level S.8(Physical Security) is available upon request.

### Durability

All 3540 Series Cylinder Mortice Locks conform with level D8 (Durability) Australian Lock Standard (AS 4145.2-2008).

### Cylinder

Five pin tumbler mechanism. Standard Lockwood oval shaped brass cylinders and brass barrels.

### Keying

#### Standard Keying

- Supplied individually keyed with two keys per lock
- 78000 key combinations
- Key blank KB2015P

#### Restricted Special Keying

Lockwood locks can be keyed to a number of controlled and/or specially keyed systems. These range from legally protected keys to protect against unauthorised duplication and can also include specially designed keying systems such as master key systems. This allows for different levels of mechanical access control.

Please refer to [assaabloy.com.au](http://assaabloy.com.au) for keying systems or contact your local sales office or customer service for specific information.

#### Standard Finish

Satin Chrome Brushed	SC
Polyester powder coat	PC

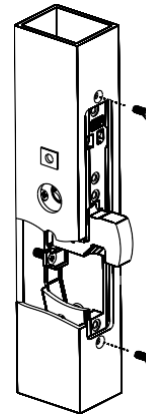

Fabricator Fixing

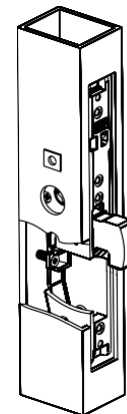

Metal Fixing

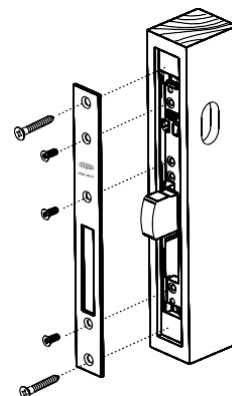

Timber Fixing

# 3540 Short Backset Mortice Deadlock



## Description

Short backset, swing bolt deadlocks suitable for narrow stile hinged doors.

Positive action deadbolt locked or unlocked by either key, turnknob, escape turn or lever handle.

Suitable for sliding doors where lock can be mounted to door jamb and deadbolt engages strike mounted to face of door.

## Features and Specifications

- 360 Degree key rotation for positive locking
- Sintered stainless steel bolt for strength
- Available in timber, fabricator and metal door fixing configurations.
- Designed and made in Australia for the specific needs of the Australian market
- Supported by a vast array of furniture options including case fix turns, surface mounted lever and turns and through fixed brass plate furniture.

## Product Details

<b>Backset</b>	23mm
<b>Bolt</b>	22mm projection sintered stainless steel.
<b>Door Thickness</b>	Suits hollow stile door sections with 28mm internal thickness and 50mm maximum external thickness. Timber Doors: 32 to 50mm.
<b>Materials</b>	High quality zinc alloy case
<b>Standard Finish</b>	Satin Chrome Brushed (SC) Polyester powder coat (PC)

# 3540 Short Backset Mortice Deadlock

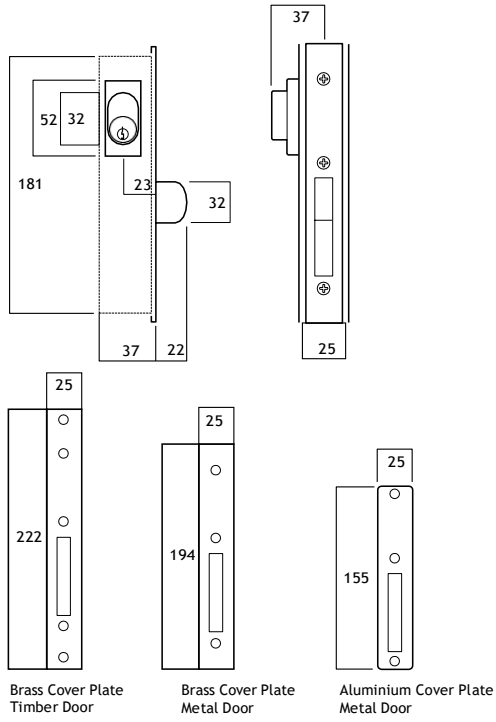

# 3540 Short Backset Mortice Deadlock

## 3540 Primary Lock (22mm Bolt Projection)

Part Numbers	Description
3540	Aluminium Coverplate for Fabricator Fixing
3640	Brass Coverplate for Metal Door
3740	Brass Coverplate for Timber Door

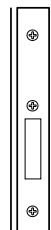

### Description

Reversible.

Primary lock can be adapted to suit any function with the addition of appropriate furniture and cylinders.

# 3541 Short Backset Mortice Hook Bolt



## Description

Short backset, swing-bolt deadlocks suitable for narrow stile sliding and swing doors. Positive action deadbolt is hooked to engage and lock into a latching or security strike when the bolt is in the thrown position.

Deadbolt is locked or unlocked by either key, turnknob, escape turn or lever handle.

## Features and Specifications

- 360 Degree key rotation for positive locking
- Sintered stainless steel bolt for strength
- Available in timber, fabricator and metal door fixing configurations.
- Designed and made in Australia for the specific needs of the Australian market
- Supported by a vast array of furniture options including case fix turns, surface mounted lever and turns and through fixed brass plate furniture.

## Product Details

<b>Backset</b>	23mm and 30mm.
<b>Bolt</b>	28mm projection sintered stainless steel. The bolt is hooked to suit sliding and swing applications and is chamfered for self latching.
<b>Door Thickness</b>	Suits hollow stile door sections with 28mm internal thickness and 50mm maximum external thickness. Timber Doors: 32 to 50mm.
<b>Materials</b>	High quality zinc alloy case
<b>Strikes</b>	Latching strike for sliding doors and non latching security strike for swing doors to protect against jemmying.

# 3541 Short Backset Mortice Hook Bolt

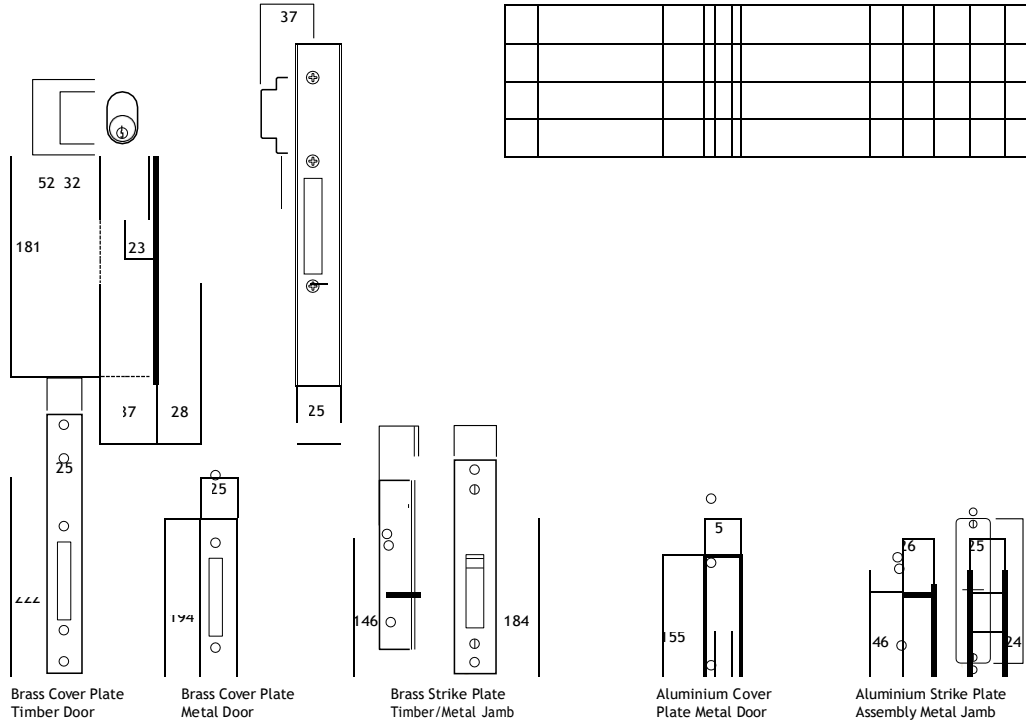

# 3541 Short Backset Mortice Hook Bolt

## Primary Lock (28mm Hook Bolt)

Part Numbers	Description
3541	Aluminium Coverplate for Fabricator Fixing
3641	Brass Coverplate for Metal Door
3741	Brass Coverplate for Timber Door

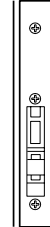

### Description

Reversible.

Primary lock can be adapted to suit any function with the addition of appropriate furniture and cylinders.

## 3541 Primary Lock Extended Backset (28mm Hook Bolt)

<b>Bolt Projection</b>	<b>28mm</b>
5541	Aluminium Coverplate for Fabricator Fixing
5741	Brass Coverplate for Timber Door

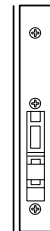

### Description

Reversible.

30mm extended backset.

Primary lock can be adapted to suit any function with the addition of appropriate furniture and cylinders.

# 3542 Short Backset Mortice Deadlock



## Description

Short backset, swing bolt deadlocks suitable for narrow stile hinged doors.

Positive action deadbolt locked or unlocked by either key, turnknob, escape turn or lever handle.

## Features and Specifications

- 360 Degree key rotation for positive locking
- Sintered stainless steel bolt for strength
- Available in timber, fabricator and metal door fixing configurations.
- Designed and made in Australia for the specific needs of the Australian market
- Supported by a vast array of furniture options including case fix turns, surface mounted lever and turns and through fixed brass plate furniture.

## Product Details

<b>Backset</b>	23mm.
<b>Bolt</b>	35mm projection sintered stainless steel
<b>Door Thickness</b>	Suits hollow stile door sections with 28mm internal thickness and 50mm maximum external thickness. Timber Doors: 32 to 50mm.
<b>Materials</b>	High quality zinc alloy case

# 3542 Short Backset Mortice Deadlock

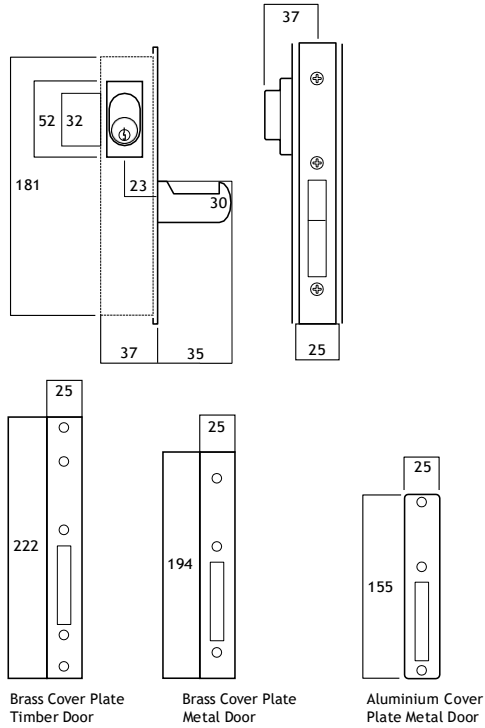

# 3542 Short Backset Mortice Deadlock

## Primary Lock (35mm Bolt Projection)

Part Numbers	Description
3542	Aluminium Coverplate for Fabricator Fixing
3642	Brass Coverplate for Metal Door
3742	Brass Coverplate for Timber Door

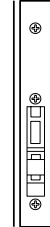

### Description

Reversible.

Primary lock can be adapted to suit anyfunction with the addition of appropriate furniture and cylinders.

# 3540 Series Short Backset Mortice Lock - Lever and Turn Options

## Description

The 3540 series is supported by vast array of furniture options including case fix turns, surface mounted lever & turns and through fixed brass plate furniture.

## Cylinder Turnsnibs

These variations interact with the cylinder mechanism of the lock either directly or via a turnsnib adaptor (included).



SP3540-T2 Teardrop Turn



SP3540-T4 Cylinder Turn



Cylinder Escape Turn SP3540-T5  
(pictured, suits left hand door)  
SP3540-T6 (suits right hand door)

## Surface Mounted Hub Driven Turnsnibs and Levers

These variations interact directly with the hub mechanism on the lock via a lock spindle (included).



SP3540-T1 Escape Turn

Designed to meet the requirements of *AS1428.1-2009 Design for access and mobility* when used in turn knob applications ONLY



SP3540-L1 45° Lever

Designed to meet the requirements of *AS1428.1-2009 Design for access and mobility*



SP3540-L2 90° Lever  
(pictured, suits right hand door)  
SP3540-L3 (suits left hand door)

Designed to meet the requirements of *AS1428.1-2009 Design for access and mobility*

# 3540 Series Short Backset Mortice Lock - Lever and Turn Options

## Through Fixed Brass Plate Furniture

In applications requiring more robust fixing a range of through fixed plates are available in slimline rectangular or round end plate options.

For positive through fixing an appropriate external plate is required from the 4800 or 5800 series brass plate furniture range.

When supplied with an appropriate lever these plates provide compliance with the requirements of AS1428.1. Where a symmetrical lever is used all configurations are site handable.

For a complete range of lever styles and finishes please refer plate door handles catalogue.



4980/70SC Square End 90 Degree Lever



5981/70SC Round End 45 Degree Lever

# 3540 Series Short Backset Mortice Lock - Accessories

## Strikes



Latching Strike with Rear Support



Security Strike for Swing Doors

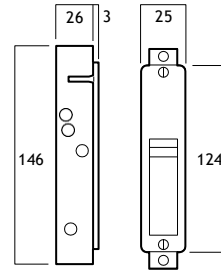

SP3540-LS  
Latching Strike Fabricator Mounting

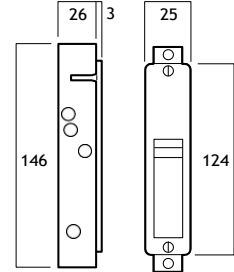

SP3540-SS  
Security Strike Fabricator Mounting

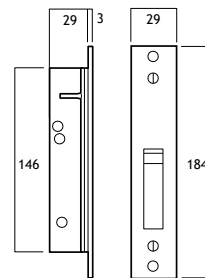

SP3640-LS  
Latching Strike Timber/Metal Jamb

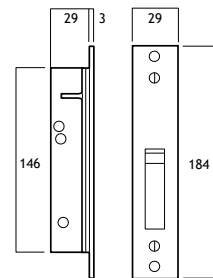

SP3640-SS  
Security Strike Timber/Metal Jamb

## Finish and Fixing Conversion Kits

Part Numbers	Description
3540-AFKITPC	Fabricator fixing powdercoat finish conversion kit.
3540-MFKITSC	Metal door mounting conversion kit
3540-TFKITSC	Brushed satin chrome timber door mounting conversion kit
3540-TFKITPB	Polished brass timber door mounting conversion kit
3540-TFKITCP	Chrome plate timber door mounting conversion kit
3540-MTSKITSC	Metal/timber frame strike mounting conversion kit

The above kits can be used to convert a fabricator fixing 3541/3542 as noted.

## Miscellaneous



SP3540-E Anti-lock Adaptor



SP3540-RB Retrofit Bracket Kit contains 2 brackets and screws.



SP3540-2 Cylinder  
SP3540-CE Cylinder  
Escutcheon and retaining clip.  
(sold separately)

# 3540 Series Mortice Lock Ordering Procedure

## Ordering Procedure

Sample part number 3542RT1SC is made up of several sections. Choose your product by selecting an option from each section.

Backset	Fixing	Lock Body	External Function	Internal Function	Finish	Options	
3	5	42	R	T1	SC	###	
Backset	Lock Body	Internal Function	Options				
23mm	3	22mm Bolt	40	R Cam Cylinder	R	No Cylinder	NCYL
30mm**	5	28mm Bolt **	41	45° Lever	L1	Latching Strike**	LS
		35mm Bolt	42	90° Lever Right Hand	L2	Security Strike**	SS
				90° Lever Left Hand	L3		
Fixing	External Function						
Fabricator*	5	R Cam	R	Escape Turn	T1		
Metal	6	No Cylinder	-	Cylinder Turn	T4		
Timber	7						
				Finish			
				Satin Chrome Brushed	SC		
				Polyester powder coat	PC		

**\*\*Note:** 30mm backset and latching and security strikes are only compatible with 28mm hook bolt variations.

\*Fabricator packs have face plates made from aluminium to suit aluminium doors

### 1. Backset

Nominate backset as required, eg. 3 = 23mm backset.

### 2. Fixing

Select fixing, eg. 5 = Fabricator.

### 3. Lock Body

Select lock body with relevant bolt type, eg. 42 = 35mm bolt.

### 4. External Function

eg. R = R cam cylinder.

### 5. Internal Function

eg. T1 = Escape Turn.

### 6. Finish

Select appropriate finish, eg. SC.

### 7. Options

Where additional options are required, specify as necessary. eg. NCYL = No Cylinder.

## Ordering Notes:

Functioned locks are available on a 10 day lead time however most functions can be achieved by combining a few primary components which will be stocked items and as such should be the preferred option when ordering.

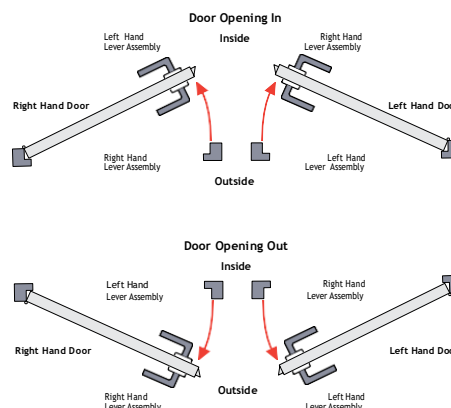



ASSA ABLOY

**Lockwood** is the leading brand in the Australian locking industry. With an established reputation for high quality products, this iconic brand provides a wide range of locking solutions to residential housing, commercial, semi-commercial, building and industrial application markets. Lockwood is supported by an extensive distribution and after-sales support network. Our customers include retailers, architects, trade and industrial personnel, locksmiths and security dealers.

**ASSA ABLOY** is the global leader in door opening solutions, dedicated to satisfying end-user needs for security, safety and convenience.

**ASSA ABLOY** is represented in all major regions, in both mature and emerging markets, with leading positions in Australia, Europe and North America.

25YEAR

MECHANICAL  
WARRANTY

### The Lockwood 25 Year Mechanical Warranty

Our belief that we manufacture the finest premium products available in today's market place is backed by the Lockwood 25 Year Mechanical Warranty, ensuring that Lockwood continues to keep Australians safe by delivering security and peace of mind.

For warranty terms and conditions, please visit [www.lockweb.com.au](http://www.lockweb.com.au) or call **1300WARRANTY**

