

THE ABEY MASONRY GUIDE



THE TRADIE'S CHOICE

CONTENTS

The Abey Masonry Guide has been developed to assist brick layers, builders, architects and specifiers in selecting and using Abey’s complete range of masonry products. Abey is a wholly owned, third generation, Australian family company. All Abey masonry products are proudly Australian made in Australia to conform to Australian Building Standards and conditions. For over 60 years, Abey have been the leaders and innovators in masonry brick ties.

Abey’s extensive range of brick ties has been developed and tested to suit Australian conditions and building codes and conform to AS 2499-2020 Standards. Abey – The Tradie’s Choice. Abey makes a range of ties to secure different types of masonry walls. Brick to brick, and block to brick and for brick veneer walls. Timber stud to brick, steel stud to brick and tilt slab to brick.



Introduction	4
Guidelines for Bricklayers	5
Learning from Our Past	6
Corrosion Zones	8
Masonry Veneer Construction	10
Steel Frame Ties	12
Sheriff Veneer Ties	14
Brick Tie Spacings for Veneer Construction	15
Sheriff Veneer Ties	16
Tremor Veneer Ties	18
Seismic Events	20
Tremor Veneer Ties	21
Masonry Cavity Construction	22
Correct Installation of Brick Ties	23
Brick Tie Spacings for Cavity Construction	24
Wind Strength Requirements for Brick Ties in Housing	25
Tie Lengths & Embedment	27
Aussie Standards Requirements For Ties Used In Cavity Masonry Walls	28
Expansion Ties	30
Expansion Ties For Brick & AAC Blockwork	31
Alligator Expansion Ties	32
Vents for Brickwork	36
Bug & Bushfire Vents	38
Ant Caps	40
Builders Strapping.....	42
Abey – The Tradie’s Choice	44
Other Products from Abey Australia	45
Non-Conforming Building Products (NCBPs)	46

INTRODUCTION

The term Masonry refers to the building of structures, such as buildings and walls, from smaller individual units most commonly used being clay bricks or concrete blocks. These are laid and stacked in rows and bound together by mortar, which is commonly a mixture of lime, cement, sand and water, which acts as a bonding agent.

The use of bricks in building has been used for centuries and has been proven to provide a very robust, low cost method of construction as well as providing to be very flexible in its design abilities. However, the materials used, the quality of the mortar and workmanship, and the construction methods in which the units are assembled and location, can significantly affect the durability of the overall construction.

Unreinforced masonry although strong in compression, is a brittle material with low tensile strength. Its ability to resist high winds or seismic loading depends upon this strength, particularly the bond strength. It also depends upon effective support and attachment to other elements of the building. Masonry is a relatively dense material too.

Since seismic induced forces are a function on the mass of the structure, larger forces will be induced than for many other more ductile structural materials such as steel and timber which offer greater flexibility.

It is important for anyone that is involved in the building process, architects, builders, bricklayers etc., to understand that unreinforced brick is incredibly hazardous and that proper masonry practices, standards in construction processes and quality materials need to be employed to ensure that walls are always correctly fixed to supporting structures with the proper use of ties and fixings. Buildings are constructed for the long term. Consideration needs to be made to account for future catastrophic events which could potentially lead to injury or death if correct procedures, standards and materials have not been used.

Whatever your level of involvement in the building process, it is your responsibility to ensure the quality, longevity, safety and adherence to correct building standards of each project you undertake.

Abey^{AU}
abeytrade.com.au

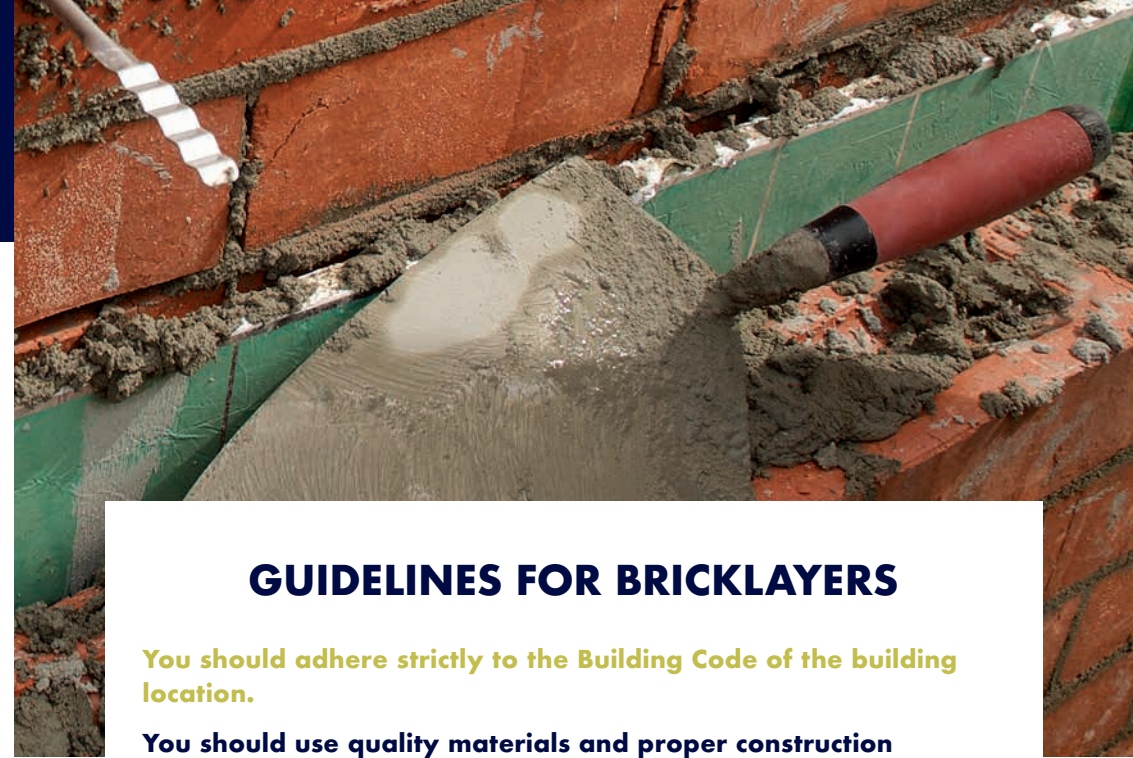

GUIDELINES FOR BRICKLAYERS

You should adhere strictly to the Building Code of the building location.

You should use quality materials and proper construction techniques in all that you build.

You should recognise that what you construct needs to withstand the test of time and will do all in your power to build it to last and be safe.

You should measure out and use the correct formula for the mortar and never take short cuts.

You should ensure the structures you build are built on adequate foundations.

You should use the appropriate brick ties for your project in accordance with the standards.

You should never leave walls unsupported and always use the correct number of ties per square metre.

You should adequately flash, joint, and ventilate your work to secure it from moisture.

You should always use 316 stainless steel brick ties near ocean environments as per standards.

You should always use quality Abey brick ties as they are true blue Australian Made.

LEARNING FROM OUR PAST

Thankfully natural disasters don't occur very often. However, when they do strike they can be sudden, unexpected and can happen anywhere, any time. When they strike with severity in populated areas the effect can be devastating. Earthquakes can have a dramatic effect on buildings. The 2010 earthquake in Christchurch, New Zealand and the 1989 one in Newcastle, Australia highlighted the need and the importance of having the right long-term building practices, products and building codes in place.

Geographically New Zealand is seismically active with 100-150 events annually. However their robust Building Code, recognise these seismic risks and were in many ways responsible for the lack of serious damage in the 2010 Christchurch earthquake which measured 7.2 without loss of life. In dramatic contrast, in January the same year in Haiti, where they have little or no building regulations, a lesser magnitude earthquake killed 200,000 people.

The 1989 Newcastle event was a 5.6 strength earthquake and was a wake up call for Australian building practices.

This catastrophic event killed 13 people and devastation was widespread effecting 10,000 buildings, with a damage bill of over one billion dollars.

The majority of damage was to unreinforced masonry, resulting from poor building practices, inferior building materials, bad planning and sheer ignorance of masonry behaviour. The performance of brick ties was highlighted as being one of the main contributing factors.

Abey designers heeded the lessons from Newcastle and developed a new range of brick ties that dramatically improved the integrity of masonry walls and made walls easier and in many cases less expensive to construct.



Newcastle, Australia



Christchurch, New Zealand

CORROSION ZONES

Any construction within a coastal area should incorporate corrosion resistant stainless steel ties for maximum effectiveness. Just as incorrect brick specification can lead to salt damage in coastal areas ordinary galvanised mild steel brick ties can result in hidden damage to brick walls.



Abey designers were the first to produce a range of products in stainless steel. Abey ties are Australian Made, they are a lighter, stronger, better lasting and competitively priced stainless steel product that meets the current building standards.

Abey's steel ties cover durability exposure classification R2, R3 and R4. Grade 304L stainless steel ties cover R3. 316L stainless steel ties cover R4. Other corrosive environments such as alpine or heavy industrial areas should also be considered as R4 environments. Abey recommend SS316L Marine Grade Brick Ties in high corrosion zone areas.

Durability Classification for Masonry Strip Steel Wall Ties			
Durability Class	Material	Surf Coast	Sheltered Coast
R2	GalZ600	> 10km	> 1km
R3	SS304L	1km to 10km	100m to 1km
R4	SS316L	0m to 1km	0m to 100m

● R2 – GalZ600 ● R3 – SS304L ● R4 – SS316L

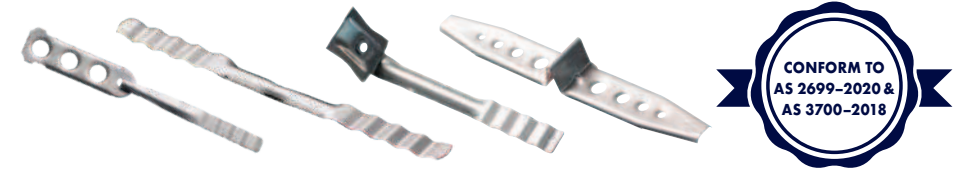

DURABILITY EXPOSURE MAP FOR MASONRY TIE SELECTION

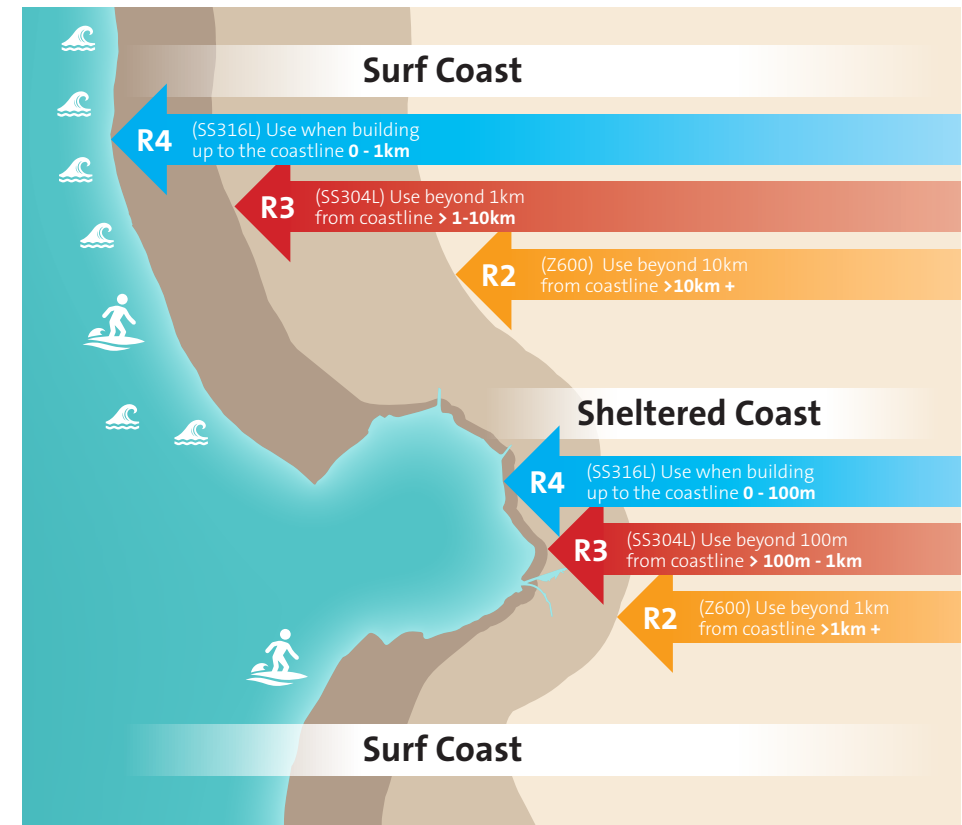

The Durability Exposure Map (above) represents an indication of corrosion zones within a coastal environment. As a general rule the closer the dwelling is located to the sea the more corrosive the environment and the greater the level of corrosion resistance, masonry anchors need to provide.

MASONRY VENEER CONSTRUCTION

A masonry veneer tie is a wall tie which is designed to tie a single leaf (wall) of masonry to a load bearing frame, providing stability to the leaf of masonry against lateral loads. Basically, the tie will transfer all forces from a masonry leaf across that cavity to the load bearing frame. The tie for brick veneer is essential to the structural soundness of a dwelling. Brick ties tying the brick leaf to timber studs are an important feature of brick veneer dwellings.

Brick ties tying the brick leaf to timber studs are an important feature of brick veneer dwellings. Contrary to popular belief the masonry is supported by the timber frame – not visa versa. In coastal conditions, the ties must be able to cope with the harsh environment and made of material that is able to resist corrosion. Abey are the innovators of stainless steel masonry ties and manufacture stainless steel masonry ties. They only cost a few cents more but have been engineered to give a maximum strength with a minimum of material and can cope with much higher corrosion stresses in the harshest of environments.

Stainless steel brick ties offer a longer service life and, although more expensive as a proportion of the overall building cost, the difference is trivial.

The ties used for brick veneer work must:

- be of a minimum classification light duty;
- for construction over 3 metres (second floor) ties must be screw fixed;
- be used at the cavity width at which it passed the AS/NZ 2699 performance test;
- have a corrosion resistance rating adequate for the environment in which it is to be used; and
- be installed in accordance with the appropriate spacings within the environment location classifications which they are being constructed. (See Page 17)

If a tie does not exhibit all of these characteristics, then the building has not been constructed to the correct building regulations.

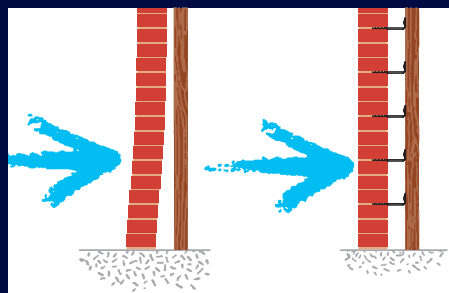

It is imperative to anchor internal load bearing walls to external masonry walls using appropriate brick ties to support and prevent the walls from pushing inwards or outwards. This transfers the lateral forces across the cavity so that it is shared between both walls, to work as one maintaining the structural integrity of the walls.



STEEL FRAME TIES

PRODUCT DESCRIPTION		CODE
Face Fix Sheriff Ties + Hex Screw To Suite Steel Frame	Light Duty R2 Galvanised Z600 (150 per box)	1000SFH
Isolation Coated Stainless Steel Face Fix Tie + Hex Screw To Suite Steel Frame	Light Duty R3 304L Stainless Steel (150 per box)	1002SFH
Isolation Coated Stainless Steel Face Fix Tie + Hex Screw To Suite Steel Frame	Light Duty R4 316L Stainless Steel (150 per box)	1004SFH
Side Fixing Light/Medium Duty Veneer Ties + Hex Screw to Suite Steel Frame	Light/Medium Duty R2 Galvanised Z600 (150 per box)	1001SFH
Side Fixing Light/Medium Duty Veneer Ties + Hex Screw to Suite Steel Frame	Light/Medium Duty R3 304L Stainless Steel (150 per box)	1003SFH

Durability Classification for Masonry Strip Steel Wall Ties

Duty	Material	Code Number	Surf Coast	Sheltered Coast
R2 (Light Duty)	Z600 Galvanised	1000SFH	> 10km	> 1km
R2 (Light/Medium Duty)	Z600 Galvanised	1001SFH	> 10km	> 1km
R3 (Light Duty)	304 Stainless Steel	1002SFH	>1km - 10km	100m - 1km
R3 (Light/Medium Duty)	304 Stainless Steel	1003SFH	>1km - 10km	100m - 1km
R4 (Light Duty)	316L Stainless Steel	1004SFH	0 -1km	0m - 100m

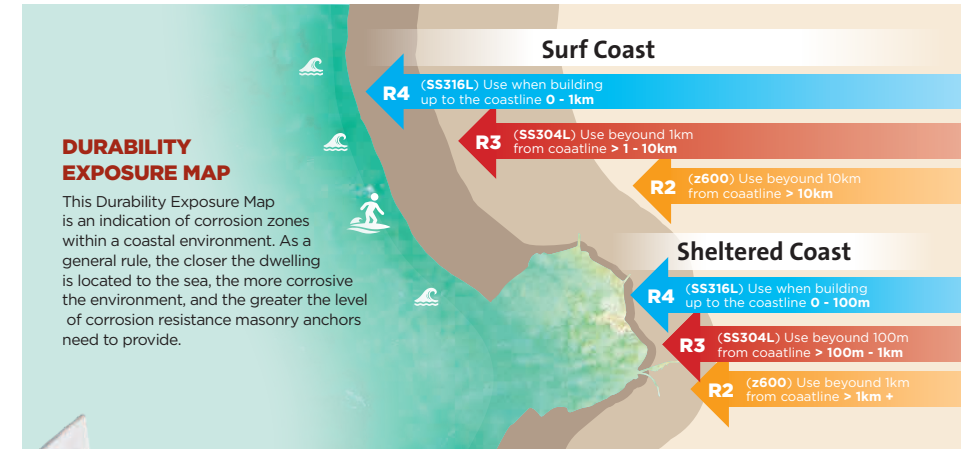

ISOLATION COATED STAINLESS STEEL FACE FIX TIE + HEX SCREW TO SUIT LIGHT DUTY STEEL FRAME

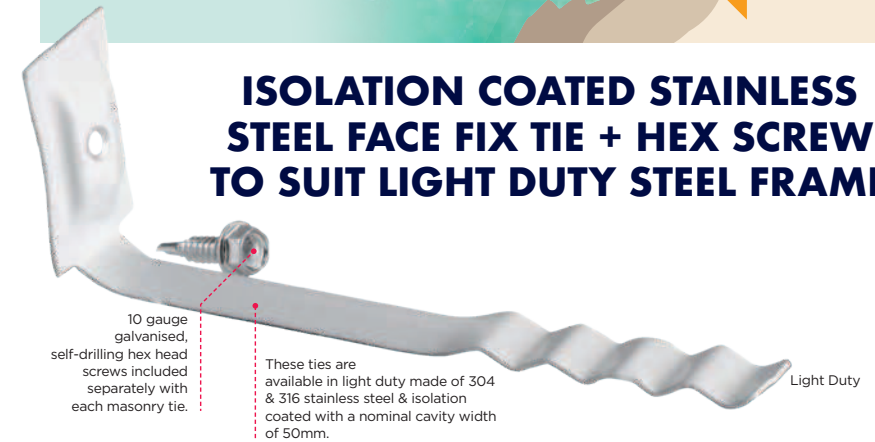

FACE FIX SHERIFF TIES + HEX SCREW TO SUIT LIGHT DUTY STEEL FRAME

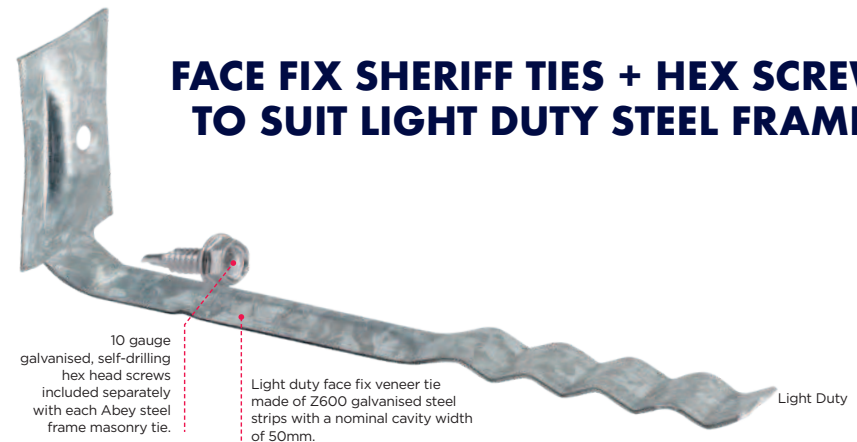

SHERIFF VENEER TIES

The Abey Sheriff Face Fixing Tie has been designed to conform to stringent Australian Standards AS2699 and AS3700. It allows for timber shrinkage and brick growth that can occur in this type of construction. It has a very narrow shank so that any mortar that drops down the cavity does not stick onto it. It's rated light duty or medium duty. And it's also available as a side fixing tie.

By screwing this tie into place you reduce the vibration that can dislodge the tie from the mortar and is mandatory in second storey construction.

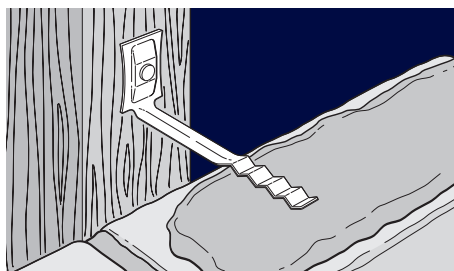

Light Duty Face Fixing Sheriff Veneer Tie for 50mm cavities (with nail)

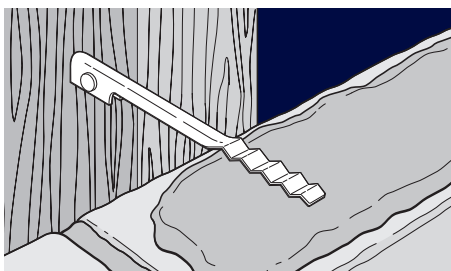

Light duty Side Fixing Sheriff Veneer Tie for 50mm cavities (with nail)



Light Duty Face Fix Sheriff Ties + Hex Screw To Suit .75mm Thick Steel Frame

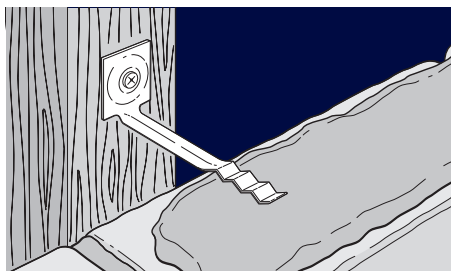

Medium Duty Face Fixing Sheriff Veneer Tie for 50mm cavities (with screw)



Light Duty Isolation Coated Stainless Steel Face Fix Tie + Hex Screw To Suit .75mm Thick Steel Frame

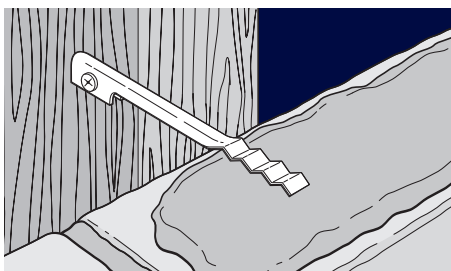

Medium Duty Side Fixing Sheriff Veneer Tie for 50mm cavities (with screw)

BRICK TIE SPACINGS FOR VENEER CONSTRUCTION

We can't over emphasise the importance of spacing brick ties. For masonry veneer construction – 600 x 450mm for 450 stud walls and 600 x 600mm for 600 stud walls. However all around edges and openings such as windows and doorways, the spacing must be reduced to 300 x 300mm or ten ties per metre squared.

Veneer Masonry		Around Edges and Openings
450 Stud Walls	600 Stud Walls	
600 x 450mm	600 x 600mm	300 x 300mm

SUITABLE FOR TIMBER, STEEL AND CONCRETE FRAMES

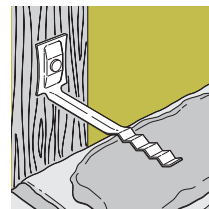

Suitable for timber frame

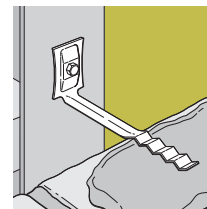

Suitable for 1.2mm steel frame

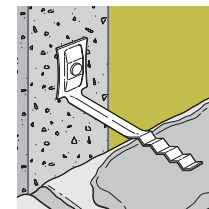

Suitable for concrete frame

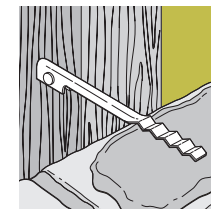

Also available as a side fixing tie

FIXING SHERIFF VENEER TIES WITH SCREWS AVOIDS HAMMER VIBRATION



Hammer vibration can loosen the connection of ties to the mortar



In light frame construction this can become a real problem especially on lower courses with semi cured mortar



Screw ties directly to the frame for both face fix or side fix ties



This eliminates the potential of hammer vibration and mortar bond

SHERIFF VENEER TIES FOR TIMBER

PRODUCT DESCRIPTION		CODE
Face Fixing Light Duty Veneer Ties Including Nails	R2 Galvanised Z600 (150 per box)	1000
	R3 304L Stainless Steel (150 per box)	1002
	R4 316L Stainless Steel (150 per box)	1004
Side Fixing Light Duty Veneer Ties Including Nails	R2 Galvanised Z600 (150 per box)	1001
	R3 304L Stainless Steel (150 per box)	1003
	R4 316L Stainless Steel (150 per box)	1005
Face Fixing Medium Duty Veneer Ties Including Screws	R2 Galvanised Z600 (150 per box)	1010
	R3 304L Stainless Steel (150 per box)	1016
	R4 316L Stainless Steel (150 per box)	1014
Side Fixing Medium Duty Veneer Ties Including Screws	R2 Galvanised Z600 (150 per box)	1011
	R3 304L Stainless Steel (150 per box)	1018
	R4 316L Stainless Steel (150 per box)	1015

Note: Nails and screwed supplied with Stainless Steel ties are Stainless Steel.

SHERIFF VENEER TIES

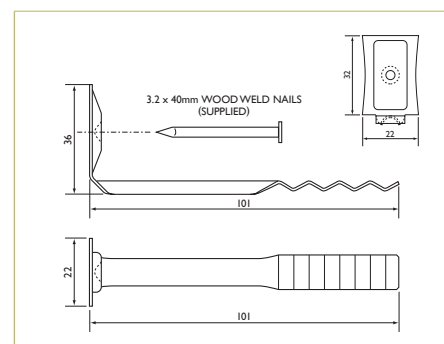

SHERIFF VENEER TIES – LIGHT DUTY
Suits 50mm cavity between brickwork and timber frame.

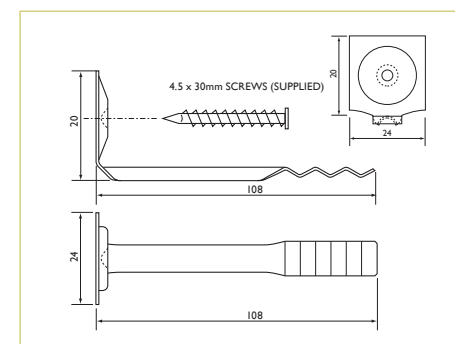

SHERIFF VENEER TIES – MEDIUM DUTY
Suits 50mm cavity between brickwork and timber frame.

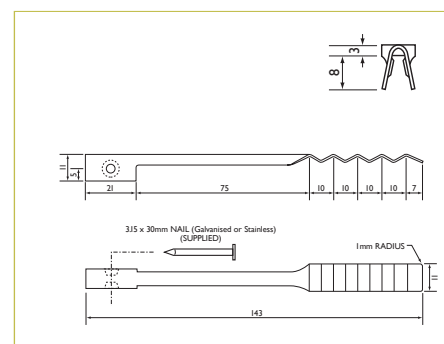

SHERIFF VENEER TIES – LIGHT DUTY
Suits 50mm cavity between brickwork and timber frame.

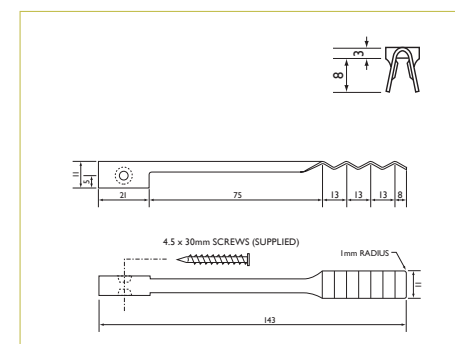

SHERIFF VENEER TIES – MEDIUM DUTY
Suits 50mm cavity between brickwork and timber frame.

TREMOR VENEER TIES

Abey Tremor Ties conform to AS2699, medium duty. They are one of the only ties that have been specifically designed to cope with movements such as those experienced in seismic events.

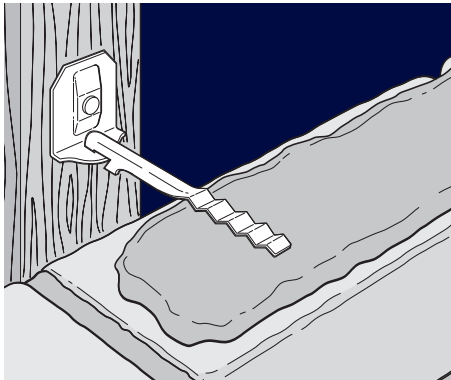

Tremor Veneer Tie for 50-100mm cavities – Medium Duty

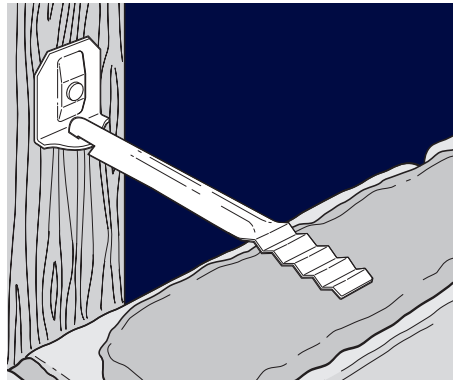

Tremor Veneer Tie for 125-200mm cavities – Medium Duty

SUITABLE FOR TIMBER (above), STEEL AND CONCRETE FRAMES

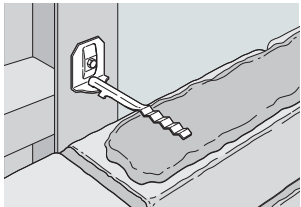

Suitable for 1.2mm steel frame

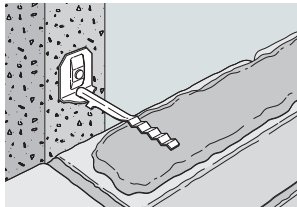

Suitable for concrete frame

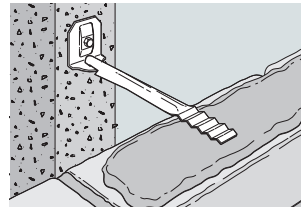

Suitable for concrete frame



WHEN ORDERING BRICK TIES FOR YOUR NEXT BUILDING PROJECT, REMEMBER:

Brick veneer is rated as light or medium duty.

Second storey construction ties must be screw fixed.

The minimum rating for cavity construction is medium duty.

If your building project is in a coastal area or within one kilometre of an industrial area, make sure you only use 316 marine grade stainless steel ties from Abey.

Control joints and openings – the vertical spacings are halved.

In veneer construction, masonry must be anchored to stud wall framing at regular spacings, including gable ends.

SEISMIC EVENTS

Australia is considered to be a reasonably safe place as far as seismic events are concerned. However, they do happen and the Newcastle disaster highlighted shortfalls in construction methods in masonry buildings.

While some advancements have been legislated insofar as coatings are concerned most wire and metal ties being sold today are have not been designed to cope with seismic events of any great magnitude. While the coatings may have eliminated the corrosion issues the structural forces would challenge most masonry ties.

Contrary to popular belief the worst type of tie to use under such circumstances would be a rigid tie, which actually breaks the way the brittle mortar when movement occurs.

Most buildings are around for the long term. To secure the safety of todays and future generations it would be a wise tradesman that uses Abey Tremor Ties, providing the best insurance policy against the destructive forces of nature.



TREMOR VENEER TIES

PRODUCT DESCRIPTION	CODE	
50mm Veneer Ties	R2 Galvanised Z600 (50 per box)	0640
	R3 304L Stainless Steel (50 per box)	0643
75mm Veneer Ties	R2 Galvanised Z600 (50 per box)	0641
	R3 304L Stainless Steel (50 per box)	0644
100mm Veneer Ties	R2 Galvanised Z600 (50 per box)	0642
	R3 304L Stainless Steel (50 per box)	0645
125mm Veneer Ties	R2 Galvanised Z600 (50 per box)	0680/50
	R3 304L Stainless Steel (50 per box)	0684/50
150mm Veneer Ties	R2 Galvanised Z600 (50 per box)	0681/50
	R3 304L Stainless Steel (50 per box)	0685/50
175mm Veneer Ties	R2 Galvanised Z600 (50 per box)	0682/50
	R3 304L Stainless Steel (50 per box)	0686/50
200mm Veneer Ties	R2 Galvanised Z600 (50 per box)	0683/50
	R3 304L Stainless Steel (50 per box)	0687/50

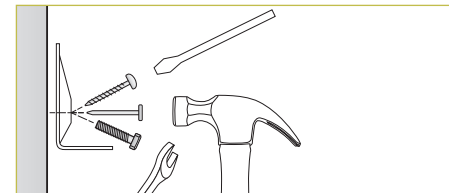

Step 1
Nail, screw or bolt 'anchor' plate into frame – for timber, steel frame or tilt slab construction.

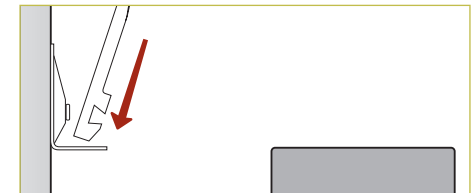

Step 2
As brick wall rises, lower 'arm' into 'anchor' plate. Reduces injury potential by eliminating jagged edges.

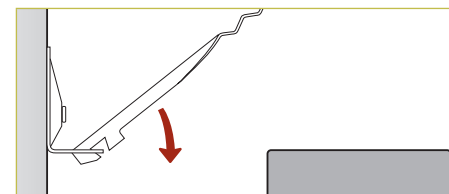

Step 3
Arm easily drops into position.

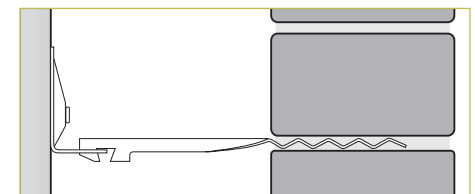

Step 4
Abey Veneer Tremor Ties provide unequalled strength and flexibility against tremors and do not break up mortar under movement.

MASONRY CAVITY CONSTRUCTION

A masonry cavity brick tie must be able to transfer lateral forces from one masonry leaf to another in the cavity wall. The use of Cavity Ties will transfer the lateral forces across the cavity so that it is shared between the outer and inner walls. Instead of working separately, the walls work as one and share the lateral forces. The cavity tie is of enormous importance to the stability of the structure of a brick cavity building.

In cavity wall construction it is imperative to tie both walls together as this, assists to hold the walls parallel and together to help strengthen the wall in stressful situations such as earth movement or high winds. This includes differential up, down or sideways movement between two skins of a cavity wall. With correctly fitted brick ties in place anchoring the internal load bearing wall to the external wall they help support and prevent the walls from pushing inwards or outwards thus maintaining the structural integrity of the walls.

In coastal conditions the ties must be able to cope with the harsh environment and made of material that is able to resist corrosion. Abey are the innovators of stainless steel masonry ties and manufacture the broadest range of stainless steel ties.

It should be remembered that stainless steel brick ties offer a longer service life and, although more expensive as a proportion of the overall building cost, the difference is trivial.

The ties used for brick cavity work must:

- > be of a minimum classification medium duty;
- > be used at the cavity width at which it passed the AS/NZ 2699 & 3700 performance test;
- > have a corrosion resistance rating adequate for the environment in which it is to be used; and
- > be installed in accordance with the appropriate spacings within the environment classifications location which they are being constructed.
(See Page 18)

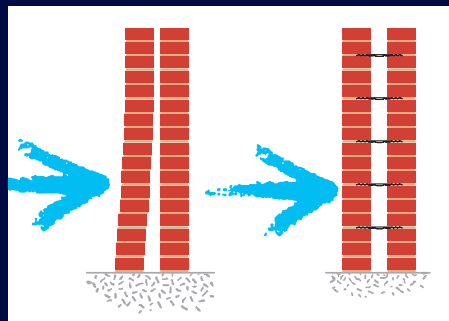

CORRECT INSTALLATION OF BRICK TIES

Ties should be correctly fitted into the fresh mortar by pressing down to embed the tail of the brick tie completely within the mortar on all sides – not just positioned onto the masonry and covered with mortar. This ensures the correct bond is created between the two leaves.

Any mortar droppings should be cleared from the installed ties to prevent moisture from crossing to the inner wall. The practice of bending installed ties 'out of harms way' should be strongly discouraged as this action affects the structural integrity of the tie as well as potentially weakening the bond of the embedded leaf.

SAFETY FIRST

Safety is a major concern on a building site and protruding ties have been known to cause injury often. To improve the OH&S standards on the work site Abey invented the 2 part Tremor Tie which negates any dangerous protrusions while providing the correct structural performance required and conforms to AS 2699 - 2020 & 3700. Available in Galvanised and Stainless Steel 50 - 100mm for both veneer and cavity wall construction.

BRICK TIE SPACINGS FOR CAVITY CONSTRUCTION

We can't over emphasise the importance of spacing brick ties. For cavity masonry – they should be spaced no further apart than 600 x 600mm or five ties per metre squared. For masonry veneer construction – 600 x 450mm for 450 stud walls and 600 x 600mm for 600 stud walls. However all around edges and openings such as windows and doorways, the spacing must be reduced to 300 x 300mm or ten ties per metre squared.

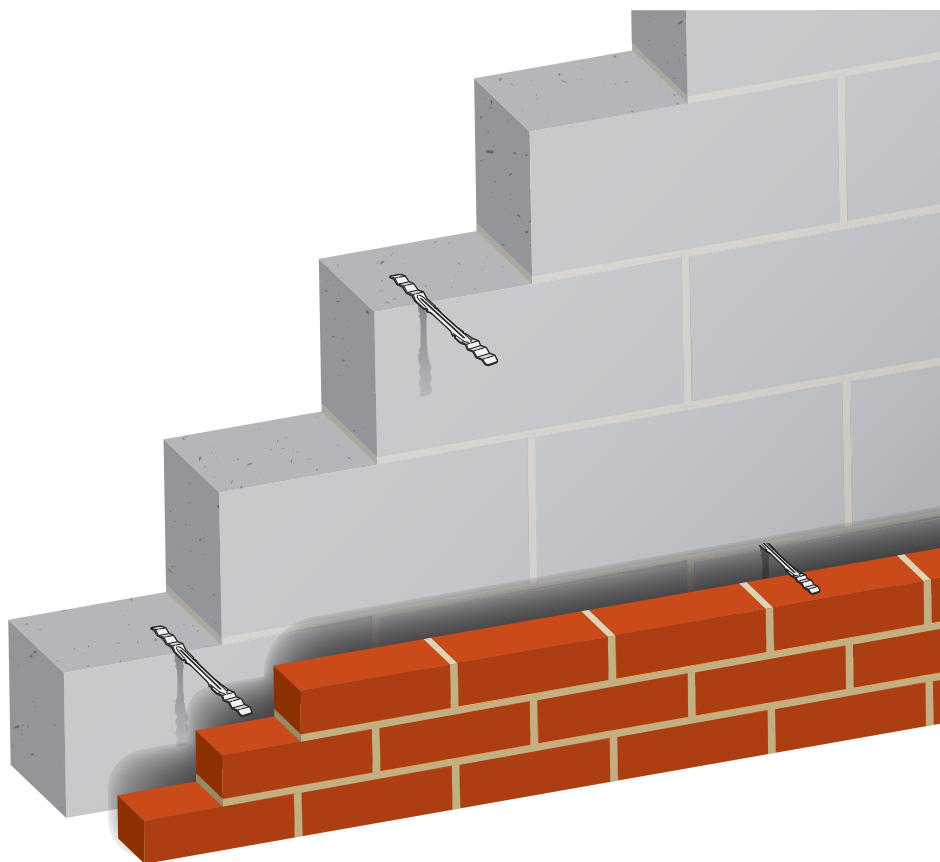

WIND STRENGTH REQUIREMENTS FOR BRICK TIES IN HOUSING

TYPICAL DEVELOPMENTS		HORIZONTAL SPACING (MM)		
Location	Classification	300	450	600
Sydney	N3	M	M	M
Melbourne	N3	M	M	M
Brisbane	N4	M	H	H
Adelaide	N3	M	M	M
Perth	N3	M	M	M
Hobart	N3	M	M	M
Darwin	C3	H	H	H
Townsville	C3	H	H	H
Cairns	C3	H	H	H

1. M = Medium duty, H = Heavy duty.
2. The table is based on wind pressures calculated for ultimate-strength limit-state design based on the external pressure coefficients applicable to the worst case for general wall areas in AS 4055 Appendix B.
3. AS 4055 classifications have been chosen as typical of developing areas in major cities. Terrain category of 2.5 is typical of developing outer urban areas and is conservative for more developed areas with a larger number of obstructions. Partial shielding is typical of intermediate situations such as acreage-type suburban development or wooded parkland and is conservative for more heavily developed or wooded areas. A topographic classification of T3 covers locations on hills up to 1:5 slope and escarpments.
4. For houses in more severe exposure conditions, such as coastal sites and the tops of hills (1:5 slope or greater) the individual site should be classified in accordance with AS 4055 and tables based on wind classification should be used.
5. Required brick tie ratings are based on the load capacities given in AS 3700.
6. Ratings are based on tie forces of 1.3 times the tributary area, as required in AS 3700 Clause 7.7.3 for veneer walls with a stiff structural backing. This situation applies to cavity walls in houses where only the inner leaf is supported (see AS 3700 Clause 7.8.4).
7. At intersecting walls, AS 3700 Clause 7.7.2(a) requires double the number of ties.
8. The first row of ties adjacent to all edges, lateral supports, control joints and opening is required by AS 3700 Clause 4.10 (d) to be within 300mm of the edge, line of support, joint or opening.

Non-cyclonic regions: N1 - W28N for 100 km/h gust, N2 - W33N for 120 km/h gust, N3 - W41N for 150 km/h gust, N4 - W50N for 180 km/h gust. **Cyclonic regions:** C1 - 180 km/h gust, C2 - 220 km/h gust, C3 - 266 km/h gust, C4 - 310 km/h gust.

HEAVY DUTY CAVITY TIES

Abey's Heavy Duty Ties come in a range of cavity widths from 50-210mm in both galvanised and stainless steel. They are the only ties to have achieved a "Heavy Duty" rating complying with AS2699.

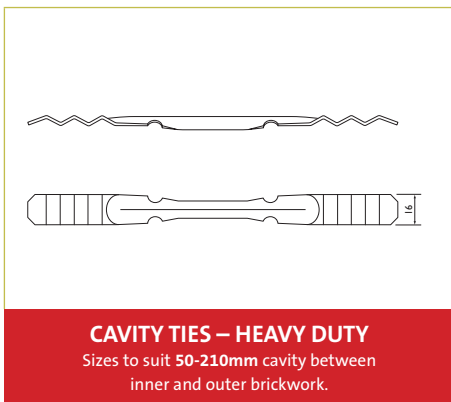
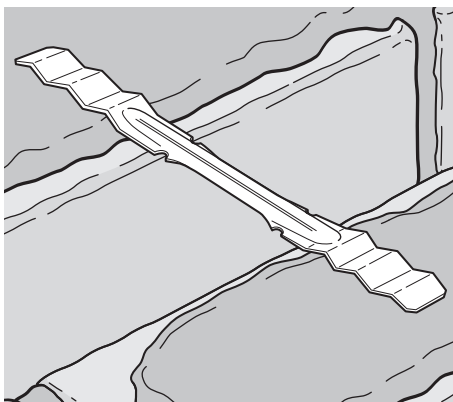

CAVITY TIES – HEAVY DUTY
 Sizes to suit 50-210mm cavity between inner and outer brickwork.



PRODUCT DESCRIPTION		CODE
NEW 50mm Cavity Ties	50	R3 304L Stainless Steel (250 per box) 0601
205mm Cavity Ties	50 – 90	R2 Galvanised Z600 (50 per box) 0590
		R3 304L Stainless Steel (50 per box) 0595
240mm Cavity Ties	90 – 130	R2 Galvanised Z600 (50 per box) 0591
		R3 304L Stainless Steel (50 per box) 0596
285mm Cavity Ties	130 – 170	R2 Galvanised Z600 (50 per box) 0592
		R3 304L Stainless Steel (50 per box) 0597
325mm Cavity Ties	170 – 210	R2 Galvanised Z600 (50 per box) 0593

TIE LENGTHS AND EMBEDMENT

When selecting brick ties they must be of the right length to ensure that they will be correctly embedded into the masonry to provide the optimum holding strength. Ties should be embedded to a minimum of 50mm into the mortar in each leaf and also take into account site tolerances for varying cavity widths. To allow for these tolerances Abey recommend that their brick tie lengths achieve an embedding of between 60-75 mm.

Suggested tie lengths to suit the varying cavity widths are shown below for cavity masonry-to-masonry wall ties.

Heavy Duty Cavity Ties for 50-210mm cavities

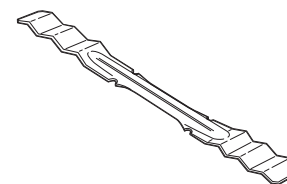

Cavity Width (mm)	Tie Length (mm)
50 – 90	205
90 – 130	245
130 – 170	285
170 – 210	325

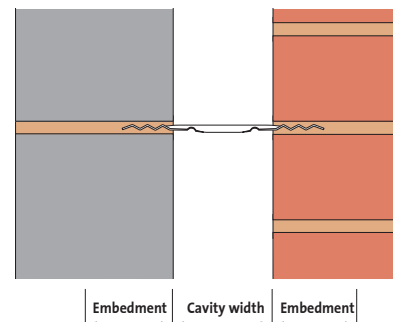

AUSSIE STANDARDS REQUIREMENTS FOR TIES USED IN CAVITY MASONRY WALLS

For a brick cavity tie to be an approved tie it must pass a performance test in AS 2699-2020 and AS 3700-2018. In his report, Dr LR Baker of Deakin University states that: "The minimum requirement is that the masonry cavity tie must pass Medium Duty classification and must exhibit the following minimum characteristics": Tension Strength (kilonewtons (kN)) – 0.5; Compression Strength (kN) – 0.6; Stiffness (kN/mm) – 1.0.



Galvanised steel wire cavity ties (even heavily galvanised wire ties) cannot be used in coastal or industrial areas because of the corrosion resistance rating given for galvanised steel wire in clause 2.9 of AS3700-2018 masonry code 1988. If galvanised steel wire ties are used in coastal or industrial areas they will not survive the harsh corrosive environment.

The ties used for brick cavity work must:

- be of a minimum classification medium duty;
- be used at the cavity width at which it passed the AS 2699-2020 performance test; and
- have a corrosion resistance rating adequate for the environment in which it is to be used.

If ties for brick cavity walls do not exhibit all of these characteristics then the building has not been constructed to building regulations

Cavity ties can only be used on the cavity width at which it passed the AS2699 test. So a conforming tie for a brick cavity width 50mm will not be conforming to standards if used on a 90mm cavity.

Ties for brick cavity walls must also have a corrosion resistance rating complying with clause 2.9 of AS3700-2018.

A ties corrosion resistance rating classifies the exposure environment in which it can be used.



EXPANSION TIES

Abey's wall expansion ties take the guesswork out of laying masonry wall expansion gaps. The patented design bites deep into the mortar and holds tight providing maximum grip in the hard yet brittle mortar, whilst providing the correct control gap (10-20mm) so necessary in masonry construction.

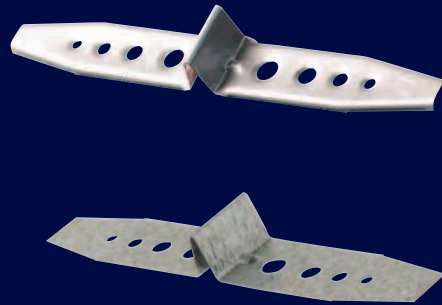

Expansion Ties for masonry brickwork and blockwork.

The importance of correctly installing expansion ties in control joints cannot be over emphasised. Not only does the brick layer have to maintain a clear space between the two panels of brickwork but he also has to make sure that the tie itself is in alignment with the wall.

Movement in masonry constructions is caused by a number of factors including temperature, moisture, and the effects of curing. The incompatibility of various building products and the differential movements between parts of a structure of dissimilar masonry materials can lead to movement damage. Building materials expand and contract at differing levels, the most dynamic example being clay brickwork which physically expands throughout its lifespan and concrete and mortar which shrinks during their curing stage.

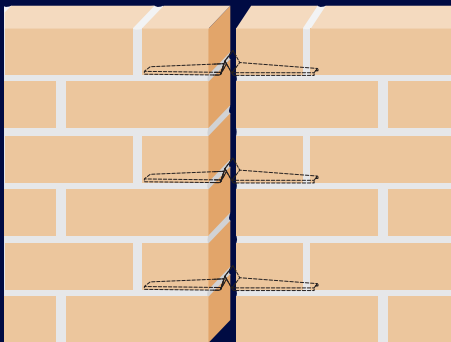

Abey's expansion ties have a positioning lip which gives both the correct gap spacings and self-alignment in the correct position dramatically reducing the possibility of cross-hatching. Available in galvanised or 316 marine grade stainless steel.

EXPANSION TIES FOR BRICK & AAC BLOCKWORK

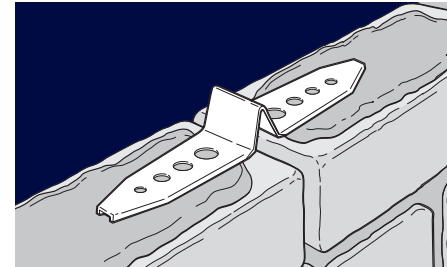

Expansion Tie for masonry brick or block walls

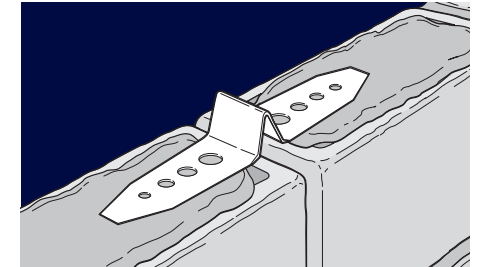

Expansion Tie for masonry walls (A.A.C block)

Abey's unique Expansion Tie has a flange which helps the brick layer line up with the end of the brick, thus maintaining its alignment throughout the wall. These ties are available in stainless steel and galvanised steel.



PRODUCT DESCRIPTION		CODE
Expansion Ties Brickwork	R2 Galvanised Z600 (20 per box)	0610
	R4 316L Stainless Steel (20 per box)	0611
Expansion Ties AAC Blockwork	R2 Galvanised Z600 (20 per box)	0580
	R4 316L Stainless Steel (20 per box)	0581

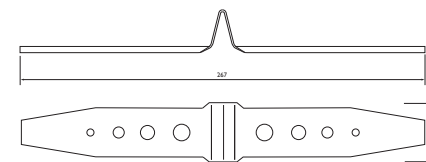

EXPANSION TIES
For masonry brick or block walls.

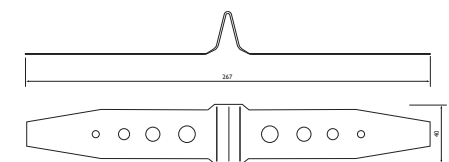

EXPANSION TIES
For masonry walls (A.A.C block).

ALLIGATOR EXPANSION TIES

Abey Alligator Ties have been designed to connect a timber, steel or concrete column to a brick or block wall. The tie itself consists of three parts – a backing plate and two jaws which act like alligator jaws to bite into the mortar bed. The tie itself whilst providing lateral support still allows for long term and thermal growth of the brickwork. Conforms to AS 3700-2018 & AS 2699-2020.

The Abey Alligator Ties are designed to keep walls vertical at all times. The “V” shape allows for normal brick growth and expansion, maintaining the control gap. The Alligator Tie can also be used to fix non load bearing walls to ceilings, still retaining that control gap and allowing for movement with the sliding action.

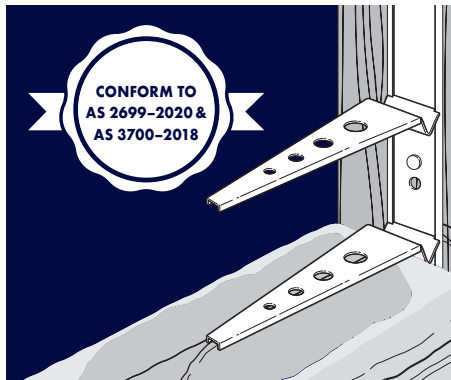

Alligator Expansion Tie for tying brickwork to frame

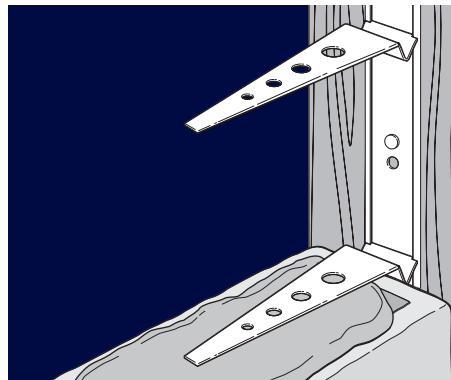

Alligator Expansion Tie for tying A.A.C blockwork to frame

SUITABLE FOR TIMBER (above), STEEL AND CONCRETE FRAMES

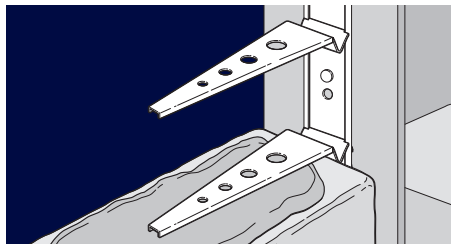

Suitable for steel frame

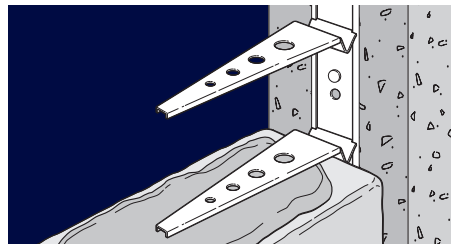

Suitable for concrete frame

ALLIGATOR EXPANSION TIES

A SNAP TO INSTALL

Abey's Expansion Alligator Ties' unique design means big savings in time and material costs. One fixing point is all that's needed, reducing nail gun costs alone by 50% and reducing labour time by over 30%. The adjustable jaws are fitted during laying to reduce injury potential. The adjustable jaws close to fit both brick and blockwork

from 60 to 200mm. Alligator Ties allow an expansion gap of $\pm 20\text{mm}$ and provide both the correct anchorage to maintain structural wall strength and stability whilst providing the correct expansion gaps necessary for movement control in masonry walls. Alligator Ties hold on tight. Their unique design gives maximum grip to brittle mortar – a common failure in many brick ties.

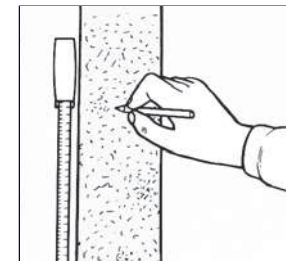

Step 1
Mark the mortar courses on column or wall at which the masonry wall will butt onto.

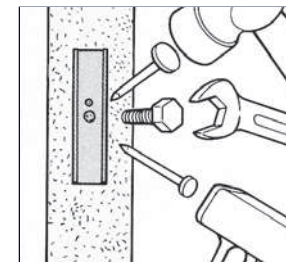

Step 2
Fix Anchor Plates to column as shown in required position using only one fixing: either by bolt in hole supplied, nail or nail gun.

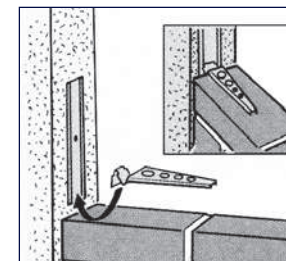

Step 3
Lay bricks or blocks until you reach first backing plate. Slide one Alligator Jaw into Anchor Plate from the bottom raising it to the centre.

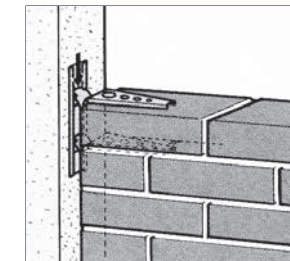

Step 4
Place brick into position, then lower Alligator Jaw onto mortar bed. Continue another row of brick or blockwork. Slide second Alligator Jaw down onto the top of the brick as shown.



Step 5
Then continue laying until you reach the next Alligator Anchor Plate. Then repeat. These spacings are normally at 600mm Centres.

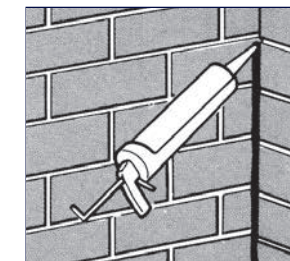

Step 6
On completion, check and clean expansion gap of any hard materials such as mortar droppings etc. and seal with appropriate highly compressible joint filler.

ALLIGATOR EXPANSION TIES

PRODUCT DESCRIPTION		CODE
Alligator Ties Block	R2 Galvanised Z600 (10 per box)	0626
	R3 304L Stainless Steel (10 per box)	0636

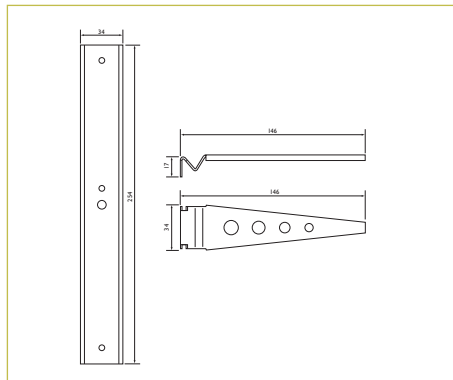

ALLIGATOR EXPANSION TIES
for tying brickwork or blockwork to frame.

Other Uses for Alligator Expansion Ties

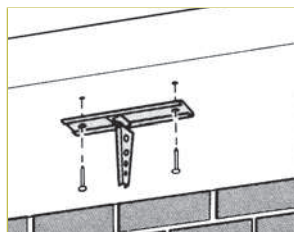

For fastening of non-load bearing walls to ceiling whilst creating control gaps, Alligator Ties can be used. Firstly slide one Alligator Jaw (only) to centre of Anchor Plate and fasten Plate into position, fixing at 2 points (one at either end of Anchor Plate).

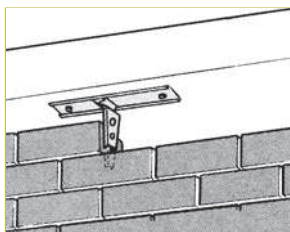

Lay block or brickwork to Alligator Tie and position Jaw between vertical mortar bed with brickwork trim end of jaw to depth of brick.

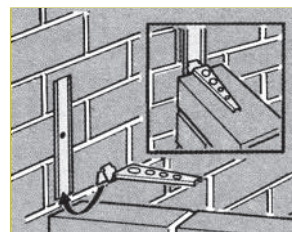

Connecting a new wall to an existing wall.

ALLIGATOR EXPANSION TIES



Alligator Expansion Ties for tying brickwork or blockwork to frame.

The need for proper planning and use of correct expansion gaps in masonry construction cannot be underestimated. Absence of ineffective control devices and poor workmanship practices can cause severe break-down in masonry constructions. The pressures a poorly constructed wall can exert are tremendous and can lead to disastrous consequences. To avoid structural damage, expansion gaps must be provided between intersecting concrete and masonry walls, columns and ceilings.

VENTS FOR BRICKWORK

The use of adequate sub floor ventilation in timber floor construction is essential to prevent rising damp and the rotting of floor joists. Abey's Slimline Vent allows for 11,000 cubic metres of free air space to help remove the moisture from the cavity and/or subfloor area. Recommended spacings are every 1.5 metres. Without ventilation there is a higher risk of corrosion of galvanised wall ties. In the wet seasons, the driving rain on the outside walls and high humidity causes condensation to form on the wall ties. However, the flow of air through the Slimline Vents helps remove the condensation, and therefore lessens the corrosion activity, making for a healthy house.

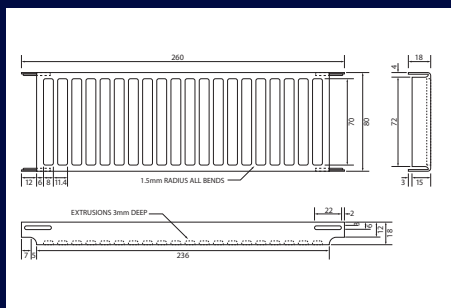
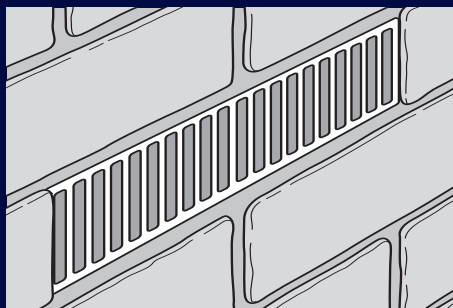



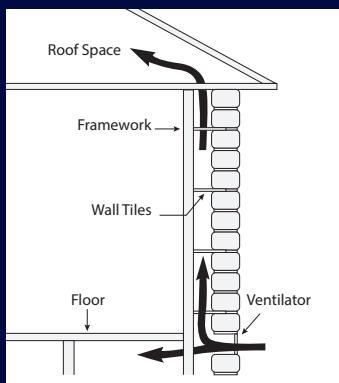

Abey's Slimline Vent allows for 11,000mm² of free air space

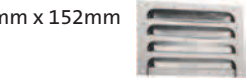
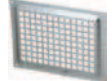

Abey's Slimline Vent allows for 11,000mm² of free air space

VENTS FOR BRICKWORK

PRODUCT DESCRIPTION		CODE
BRICK VENTS/BUG & BUSHFIRE VENTS WITH MESH – GALVANISED Slimlines 236mm x 80mm	Gal Z275 (20 per box)	0400/20
	With Wire Mesh (Bushfire Areas)	0400M
 Vents 230mm x 165mm	Gal Z275 (20 per box)	0401/20
	With Mesh (Bushfire Areas)	0401M
 Vents 230mm x 75mm	Gal Z275 (20 per box)	0402/20
	With Wire Mesh (Bushfire Areas)	0402M
	SS304L	0402S
	With Wire Mesh (Bushfire Areas)	0402MS
 LVD Brick 230mm x 165mm	Gal Z275	0420
VENTS – GALVANISED LVD Flt Face 230mm x 152mm	Gal Z275	0423
	With Wire Mesh (Bushfire Areas)	0423M
 Large Flt Face 260mm x 195mm	Gal Z275	0424
 Small Flt Face 260mm x 108mm	Gal Z275	0425
	With Wire Mesh (Bushfire Areas)	0425M
 Hooded 230mm x 165mm	Gal Z275	0426
	With Wire Mesh (Bushfire Areas)	0426M
 Magpie 255mm x 90mm	Gal Z275	0427

BUG & BUSHFIRE VENTS

Abey Bug and Bushfire Vents help to prevent the penetration of hot ash and burning debris entering the sub-floor areas. They are designed for the construction of buildings in bushfire prone areas, and comply to AS3959-1991 standards. A common cause of building loss/damage is not always due to the direct effects of bushfire, but the fallout of burning debris entering buildings via sub-floor vents and creating a secondary fire situation. Abey Bug & Bushfire Vents 2mm spark arrestor mesh also helps to retard the potential infestation of pests such as the European wasp, from entering the sub floor areas of buildings.

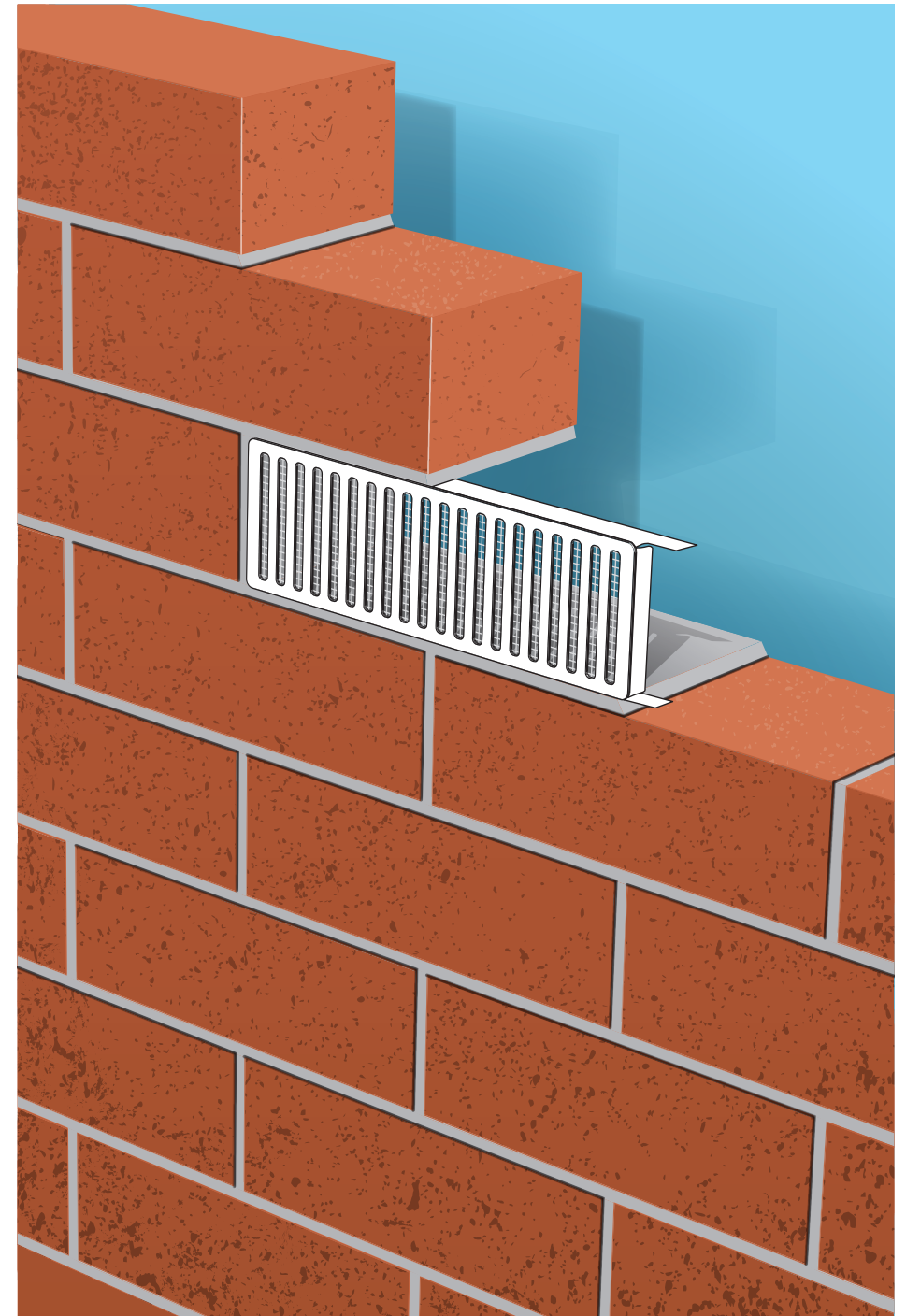
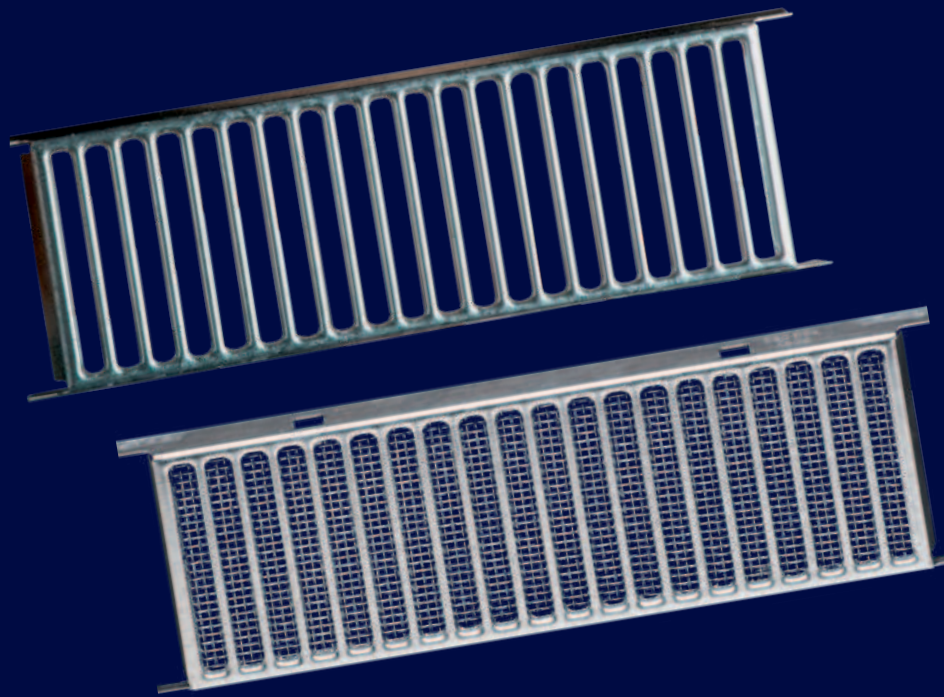

ANT CAPS

Australia is one of the world's largest continents and has one of the largest concentrations of termites (white ants), with over 5000 species spread throughout every state and territory. Whilst the majority of termites are harmlessly restricted to eating grasses and fallen timber in rural areas, many are attracted to making our homes theirs. With the potential of eating us out of house and home. Abey manufacture a range of termite shields (ant caps or stump caps) to protect buildings from subterranean termite attack that fully comply with Australian Building Standards AS3660-1993 to be used in all new and retrofit applications.

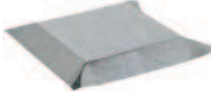
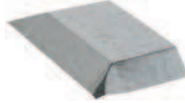

ANT CAPS

PRODUCT DESCRIPTION	DISC CODE	CODE
TERMITE CAPS – GALVANISED Termite Caps 100mm x 100mm 	(50 per pack)	BL 2151/50
	Hole (50 per pack)	BL 2152/50
	Restump (50 per pack)	BL 2153/50
Termite Caps 230mm x 230mm 	(25 per pack)	BL 2155/25
Half Termite Caps 230mm x 115mm 	(25 per pack)	BL 2156/25

Standards for termite caps:

Abey's termite caps fully conform to AS3660-1993 standards (prevention of buildings from subterranean termites). Plus they give the added advantage of providing tie-down anchorage between bearers and pier (stumps).

- 1 Must have a plane surface of sufficient dimension to full cover top of pier (stump).
- 2 Must be constructed of galvanised steel 0.5mm thickness (almost twice the thickness of old type of ant cap).
- 3 Angle of edges turned down at a 45° angle from horizontal.
- 4 Surfaces on all sides should protude at least 40mm from the vertical face of the pier (stump).

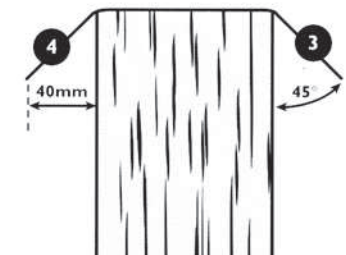
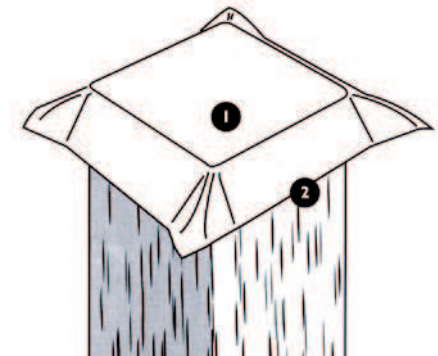

BUILDERS STRAPPING

A versatile Australian Made product, available in 25mm and 30mm widths in various lengths, either galvanized or stainless steel in thickness of 0.6mm, 0.8mm, 1.0mm and 1.2mm. Comes with easy to use dispenser pack.



Metal Strapping

Tensioned with Stud Straps Example. Refer to AS1684:2:2010/AS1684:3:2010 and a Structural Engineer for further information.

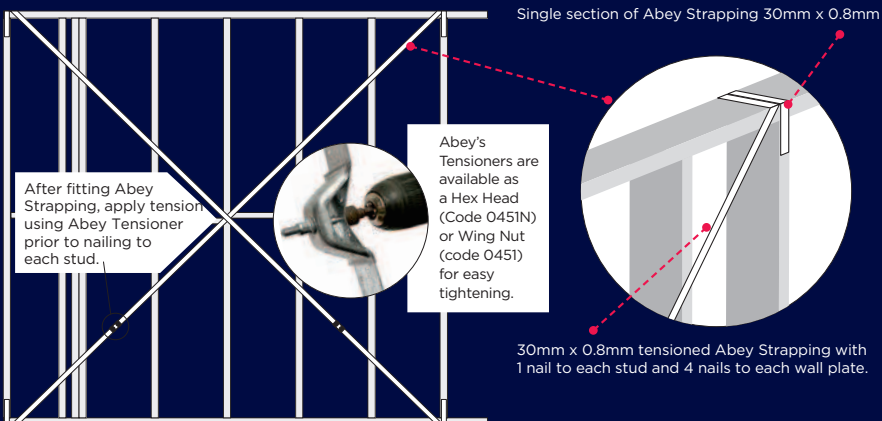

BUILDERS STRAPPING

NON STRUCTURAL

PRODUCT DESCRIPTION	25MM GALVANISED	CODE	MAX TENSION (kN)
PERFORATED STRAPPING – Z275 GALVANISED 25mm wide	25mm x 0.6mm x 6m	0428	N/A
	25mm x 0.6mm x 15m	0430	N/A
	25mm x 0.6mm x 30m	0431	N/A
	25mm x 0.8mm x 15m	0432	N/A
	25mm x 0.8mm x 30m	0433	N/A
	25mm x 1.0mm x 15m	0434	N/A
	25mm x 1.0mm x 30m	0435	N/A



PRODUCT DESCRIPTION	CODE	MAX TENSION (kN)
25MM STAINLESS STEEL 304 25mm x 0.7mm x 30m	0471	N/A
30MM STAINLESS STEEL 304 30mm x 0.7mm x 15m	0476	N/A

STRUCTURAL

Structural Engineer Note: The kN rating in the above tables are derived under optimal test conditions. Abey Builders Strapping is compliant with AS1684.2:2010/AS1684.3:2010. A structural engineer should be consulted to ensure a correct brace is used.

PRODUCT DESCRIPTION	30MM GALVANISED	CODE	MAX TENSION (kN)
PERFORATED STRAPPING – Z275 GALVANISED 30mm wide	30mm x 0.8mm x 15m Plain Z600	0439P	8.3
	30mm x 0.8mm x 6m	0459	6.4
	30mm x 0.8mm x 15m	0460	6.4
	30mm x 0.8mm x 30m	0461	6.4
	30mm x 1mm x 6m	0464	8.0
	30mm x 1mm x 30m	0463	8.0
	30mm x 1.2mm x 30m Plain	0466P	13.1

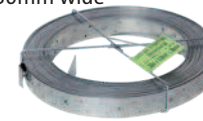

PRODUCT DESCRIPTION	CODE	MAX TENSION (kN)
30MM STAINLESS STEEL 316 30mm x 0.9mm x 15m	0475	14.3

STRAPPING TENSIONERS	CODE
Tensioners with wing nut (10 per bag)	0451
Tensioners with Nutsert (10 per bag)	0451N



THE TRADIE'S CHOICE

For over 60 years Abey Australia has been providing fellow Australians quality products that have endured the test of time. Renowned for their focus on quality and innovation, Abey Products are held in the highest regard amongst professional trades people.



The Abey head office and manufacturing facility, located in Melton, Victoria, employs over 200 full and part-time staff. There are local Abey offices throughout Australia. Today Abey is represented in all Australian states, manufacturing and marketing a vast range of over 2,000 products including plumbers clipping systems, flexible connectors, gas flueing systems, stainless steel building connectors, flashings, sinkware, tapware and a broad range of accessories across their business areas.

OTHER PRODUCTS FROM ABEY AUSTRALIA



BOLTED CLIPS



FLUE KITS



GAS FLUEING



PLASTIC PLUMBING



SINKWARE



TAPWARE



BATHS & BASINS

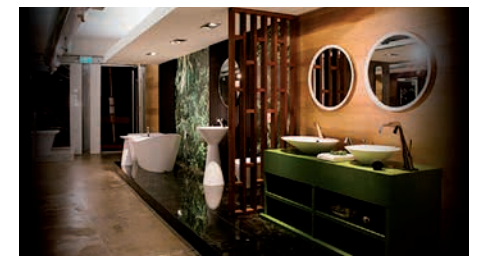

DESIGNER PRODUCTS

Coating mass

The coating mass is essential and describes the minimum coating mass per square metre of sheet steel. It is important to note that to ensure compliance to the standards, it is not enough to specify coating type only, without specifying coating mass, ie Galvanised Z275, which is the amount of corrosion protection required for the environment in which the product will be used.

Designation of common coating classes

Coating Class Designation	Coating Type	Coating Mass
Galvanised Z275	Zinc	275 grams per square metre
Galvanised Z600	Zinc	600 grams per square metre

Correct material selection, handling and installation

The key to obtaining the full benefits of the corrosion resistant coatings applied to steel building products lies in correct material selection, good handling, proper installation practices, and sensible maintenance.

Base Metal Thickness

Base Metal Thickness (BMT) relates to the thickness of the base metal. It provides the structural load bearing capacity and integrity of the product. Structural capability is a function of base metal thickness and steel grade, whereas corrosion performance is determined by coating thickness and type.

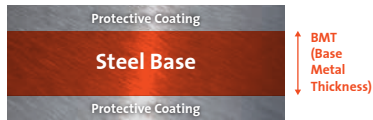

Coating types and compatibility with other metals

Due to the corrosive nature in masonry structures, Z600 galvanised is the minimum coating class to be used. Please note, Zinalume® does not conform as it is highly corrosive in mortar.

Coating types and compatibility with corrosive environments

There are highly corrosive environments that require special attention – metals and coatings that come in contact with mortar such as brick ties and brick vents, and/or in corrosive industrial or coastal environments as such as plumbing clips and fasteners. In extreme corrosive environments, coated products will not offer enough protection. In these instances a higher quality level of metal should be specified. For example, when building near corrosive coastal or industrial environments products such as stainless steel SS304L or marine grade SS316L should be specified.

Corrosion zones

The Masonry Durability Exposure Map represents an indication of corrosion zones within a coastal environment. As a general rule, the closer the dwelling is located to the sea, the more corrosive the environment, and the greater the level of corrosion resistance, steel based products need to provide.

Australian studies have shown that salt fallout from the ocean can carry in land in excess of 30 kilometres. Coated sheet steel and strip steel building products, such as brick ties, should be selected based on the distance of the structure from the coast and whether that coast opens to a sheltered bay or clear ocean. As can be seen in the case of close proximity to severe marine environment, coated steel products should not be used and Marine Grade Stainless Steel is the only option, as it offers the correct level of corrosion resistance. Coated steel products just do not offer sufficient long-term protection. (Please refer to appropriate AS/NZS



Durability Classification for Masonry Strip Steel Wall Ties			
Durability Class	Material	Surf Coast	Sheltered Coast
R2	Galvanised Z600	> 10km	> 1km
R3	Stainless Steel 304L	1km to 10km	100m to 1km
R4	Stainless Steel 316L	0m to 1km	0m to 100m

Corrosion classification by Abey

Abey are a proud Australian company that have been designing and manufacturing the highest quality strip steel products for the building industry for over 60 years. These products conform to all Australian Building Codes and Standards. To assist merchants, specifiers and end users to identify the corrosion resistance levels of their products, Abey have embarked on a Quality Assurance labelling program that is colour coded to show the level of coating (below), and where applicable, corrosion classification in which they can be used. When choosing an Australian Made Abey product, you can rest assured that the product you use is a quality product that conforms to all building relevant codes. It pays to support Australian Made.



Coating	Classification	Product	Use
Stainless Steel 316L	R4	Stainless Steel	Severe Marine grade corrosion resistance. Use in constructions in extreme coastal environments, Alpine or Corrosive Industrial areas.
Stainless Steel 304L	R3	Stainless Steel	Medium Duty corrosion resistance. Use in constructions environments close to Ocean or Corrosive environments.
Galvanised Z600	R2	Galvanised	Moderate Duty corrosion resistance. Use in constructions in moderate environments.
Galvanised Z275	R1	Galvanised	Mild Duty corrosion resistance.

Please note, all Australian Standards should be read to incorporate any updates to the most recently published versions.

The importance of buying Australian Made

Buying Australian Made products not only supports the manufacturing sector and Aussie jobs but also controls the quality of products that are being used, and the longevity and structural integrity of the dwellings that are being constructed.

Australian manufacturers are governed by stringent laws and building codes. They can be held accountable, whereas imported products do not operate under the same rules. They don't stand by their products. They don't understand or support the trades and industries they sell to and they don't employ Australians. But most importantly some of the products that are bought in to our country do not conform to our Building Laws, are of dubious and inconsistent quality, and can have unsafe and negative long-term effects on the projects that they are used in, with little retribution to the original manufacturer.

Abey^{AU}



Abey^{AU}

abeytrade.com.au

Victoria – Abey Head Office

Phone: 03 9747 7777

New South Wales

Phone: 02 8572 8572

Queensland

Phone: 07 3440 5500

Western Australia

Phone: 1800 809 143

South Australia

Phone: 1800 809 143

Email: mail@abey.com.au